



Modular 8-Port Mid-span Power over Ethernet Injector

KPOE-800-1P
KPOE-800-2P

Installation Guide



DOC.090511

(C) 2008 KTI Networks Inc. All rights reserved. No part of this documentation may be reproduced in any form or by any means or used to make any derivative work (such as translation or transformation) without permission from KTI Networks Inc.

KTI Networks Inc. reserves the right to revise this documentation and to make changes in content from time to time without obligation on the part of KTI Networks Inc. to provide notification of such revision or change.

For more information, contact:

United States KTI Networks Inc.
P.O. BOX 631008
Houston, Texas 77263-1008

Phone: 713-2663891
Fax: 713-2663893
E-mail: kti@ktinet.com
URL: <http://www.ktinet.com/>

International Fax: 886-2-26983873
E-mail: kti@ktinet.com.tw
URL: <http://www.ktinet.com.tw/>

The information contained in this document is subject to change without prior notice. Copyright (C)
All Rights Reserved.

TRADEMARKS

Ethernet is a registered trademark of Xerox Corp.

FCC NOTICE

This device complies with Class A Part 15 the FCC Rules. Operation is subject to the following two conditions: (1) This device may not cause harmful interference, and (2) this device must accept any interference received including the interference that may cause.

CE NOTICE

Marking by the symbol indicates compliance of this equipment to the EMC directive of the European Community. Such marking is indicative that this equipment meets or exceeds the following technical standards:

EMC Class A

EN 50081-1/1992 :EN55022:1994/A1:1995/A2:1997 Class A

EN61000-3-2:2000

EN61000-3-3:1995/A1:2001

EN 55024:1998/A1:2001

IEC 61000-4-2:1995

IEC 61000-4-3:1995

IEC 61000-4-4:1995

IEC 61000-4-5:1995

IEC 61000-4-6:1996

IEC 61000-4-8:1993

IEC 61000-4-11:1994

Table of Contents

1. Introduction	5
1.1 Features.....	5
1.2 Product Panels	6
1.3 Mid-span Injector Function	6
1.4 Model Definition	7
1.5 Specifications.....	7
2. Installation	9
2.1 Unpacking.....	9
2.2 Safety Cautions	9
2.3 Mounting the Injector	10
2.4 Installing Power Module.....	12
2.5 Applying AC Power.....	13
3. Making LAN Connections.....	14
3.1 Making Switch Port Connections	14
3.2 Making Powered Device Connections	15
3.3 LED Indication	16
4. Applications.....	17
4.1 Application with Low Power Requirements.....	17
4.2 Application with High Power Requirements.....	17

1. Introduction

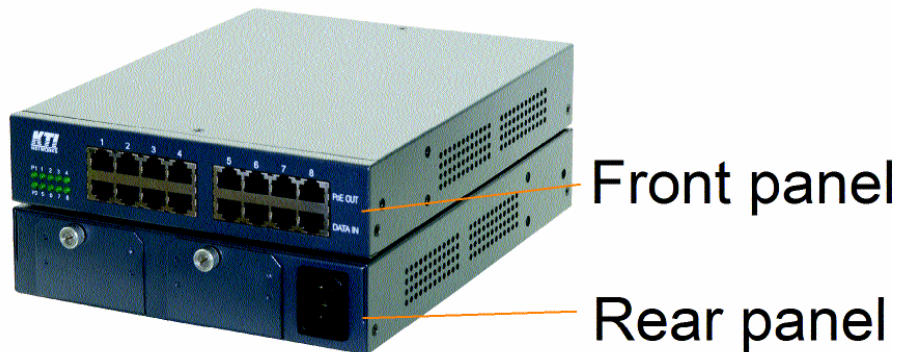

The Power over Ethernet (PoE) injector is a mid-span power injector designed and tested for use with all IEEE802.3af compatible PoE Powered Devices (PDs). The PoE injector sits between a switch port and the PoE powered device, providing inline power capability to an un-powered switch port.

The injector provides modular power design. For high power applications, the injector can be installed with 2 power modules to support full PoE power up to 120W for eight powered devices. For low power applications, the injector can work with only one power module and support PoE power up to 60W for eight connections. This flexible modular power design provides cost-effective solutions for different requirements.

The PoE injector offers the following significant benefits:

- **Low purchase cost** - Installing an injector costs less than upgrading to new PoE switches, since PoE injectors can easily connect with existing Ethernet switches.
- **Low installation cost** - The injector is a plug & play product making the installation much easier than a PoE switch. There is no need any software configuration.
- **Protecting existing and future investment** – The PoE injectors are interoperable with all Ethernet switches and most terminals. PoE injectors can be used in conjunction with different switch vendors, and end-terminals, which comply with the PoE 802.3af standard. It protects your existing network installation and future investment as well.

1.1 Features

- Supports 8 Ethernet ports
- Full IEEE802.3af compliance
- Gigabit Ethernet support
- Transparent to switch functionality
- Standard user safety protection

- Modular PoE power upgradability
- 19" rack mounting support

1.2 Product Panels

The following figure illustrates the faces of the injector:

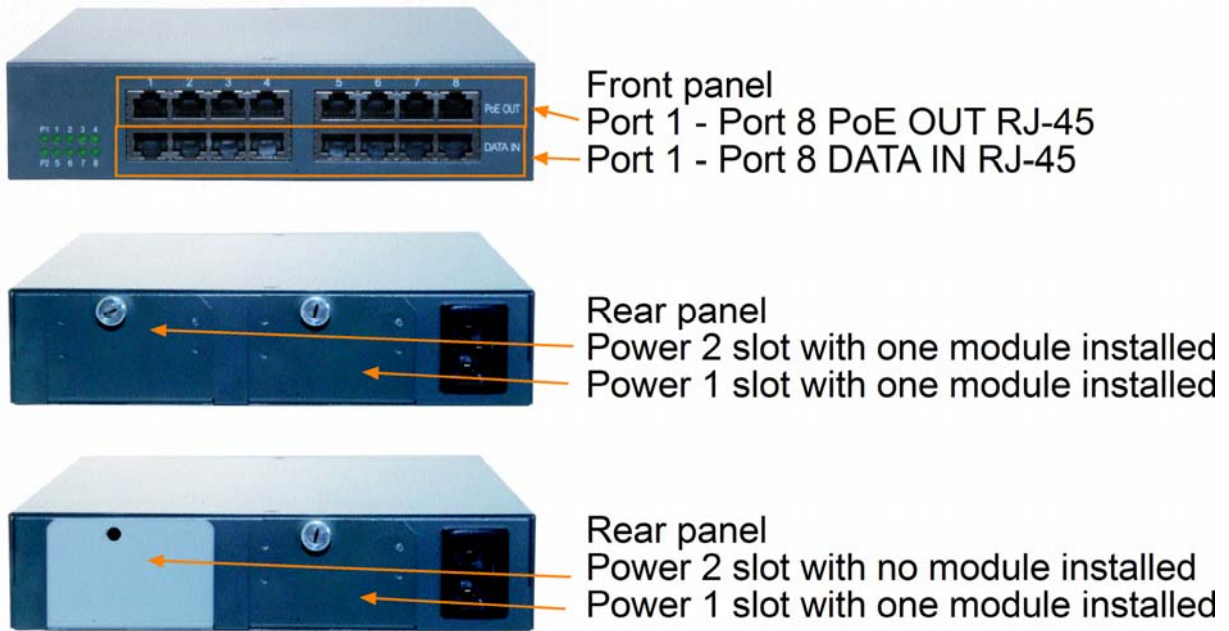

1.3 Mid-span Injector Function

The PoE mid-span power injector is designed and tested for use with all IEEE802.3af compatible PoE PDs. The PoE injector sits between a switch port and the PoE powered device, providing inline power capability to an un-powered switch port.

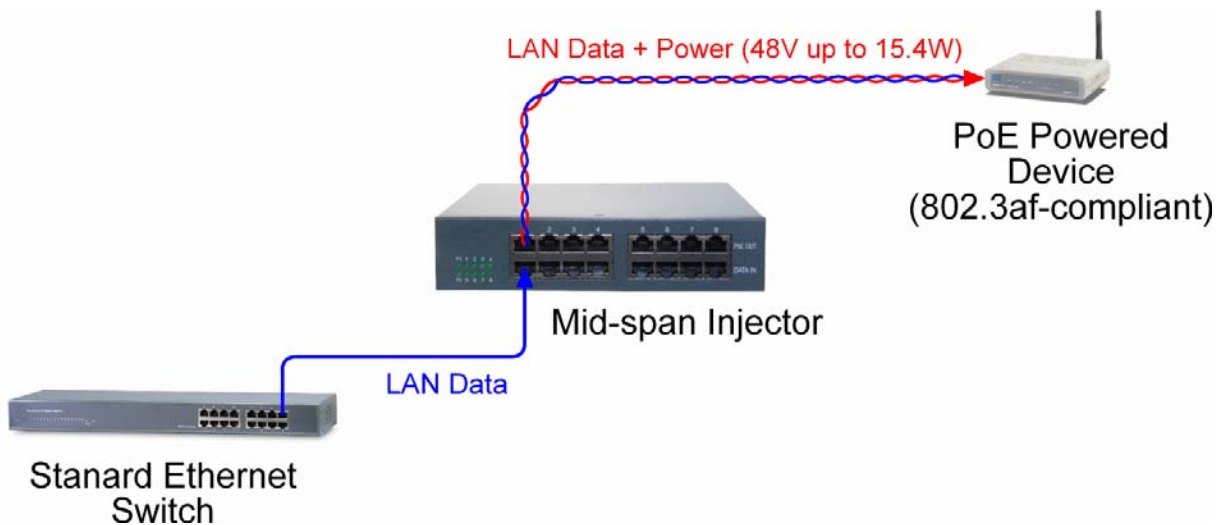

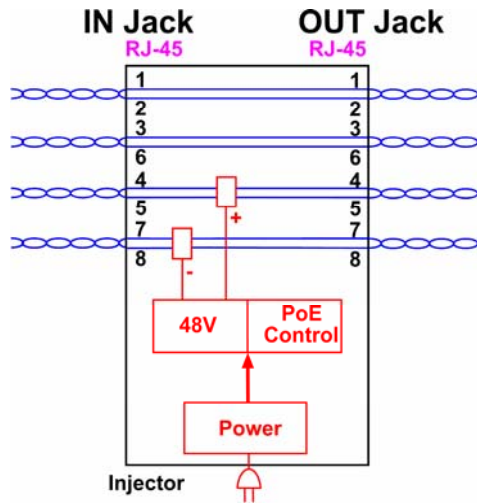

1.4 Model Definition

KPOE-800-1P	1 Power Model	The injector unit with one pre-installed power module
KPOE-800-2P	2 Power Model	The injector unit with two pre-installed power modules
KPOE-800P60W	Power Module	PoE 60W Power Module
KPOE-800BSET1	BRACKET SET1	The bracket set for mounting one unit in a 19" rack
KPOE-800BSET2	BRACKET SET2	The bracket set for mounting two units in a 19" rack

1.5 Specifications

Network Ports

8 connections to 8 non-PoE switched ports
 8 connections to 8 PoE powered devices

Compatible Std.

Ethernet Ethernet, Fast Ethernet & Gigabit Ethernet

PoE Standard

IEEE 802.3af compliance

Data IN Jack

Shielded RJ-45
 IEEE 802.3, 10Base-T, 100Base-TX, 1000Base-T std.
 Hot-plug support

PoE OUT Jack

Shielded RJ-45
 IEEE 802.3, 10Base-T, 100Base-TX, 1000Base-T std.
 Hot-plug support

PoE OUT Cable

4-pair Cat.5, 5e, or 6
 Distance mid-span up to 100 meters

PoE OUT Voltage

48VDC on jack pin 4/5 (V_{48dc+}) and jack pin 7/8 (V_{48dc-})

PoE OUT Power

Total 60 Watts for 8 connections with one power module
 Total 120 Watts for 8 connections with two power modules

PoE OUT Protection

Port power shut down protection for events:
 - Incompliant PD detection,

- Disconnection,
- Overload,
- Over-current
- Short-circuit,
- Under voltage

Power Module Slots

2

LED Indicators

Power module status x 2 , Port PoE status x 8

Power Input

Voltage: 100 ~ 240VAC, Frequency: 50/60Hz

Power Consumption

1 Power Model: 68W max. (60W for remote PoE PDs)

2 Power Model: 136W max. (120W for remote PoE PDs)

Power Dissipation

1 Power Model: 3W

2 Power Model: 6W

Dimension

190 x 238 x 43 mm (WxDxH)

Housing

Enclosed metal with no fan

Mounting Support

19" rack mountable

Temperature

Operating: 0°C ~ +40°C, Storage: -20°C ~ 85°C

Relative humidity: 5 ~ 95% non-condensing

Certificate

FCC

Part 15 Class A

CE/EMC

EMI EN50081-1 Class A

EMS EN55024

EN 50081-1/1992 :

EN55022:1994/A1:1995/A2:1997

EN61000-3-2:2000

EN61000-3-3:1995/A1:2001

EN 55024:1998/A1:2001

IEC 61000-4-2:1995 ESD Test

IEC 61000-4-3:1995 RS Test

IEC 61000-4-4:1995 EFT/BURST Test

IEC 61000-4-5:1995 Surge Test

IEC 61000-4-6:1996 CS Test

IEC 61000-4-8:1993 Magnetic Field

IEC 61000-4-11:1994 Voltage Int. Dips

2. Installation

2.1 Unpacking

Check that the following components have been included:

- Information CD
- The device unit
- An AC power cord

If any item is found missing or damaged, please contact your local reseller for replacement.

The following are available optional accessories:

- 19” rack mounting bracket kits

The brackets are used for mounting the devices in a 19” rack.

- PoE 60W Power Module

The module is used for upgrading the mid-span injector power up to 120W.

2.2 Safety Cautions

To reduce the risk of bodily injury, electrical shock, fire, and damage to the product, observe the following precautions.

- Do not service any product except as explained in your system documentation.
- Opening or removing covers may expose you to electrical shock.
- Only a trained service technician should service components inside these compartments.
- If any of the following conditions occur, unplug the product from the electrical outlet and replace the part or contact your trained service provider:
 - The power cable, extension cable, or plug is damaged.
 - An object has fallen into the product.
 - The product has been exposed to water.
 - The product has been dropped or damaged.
 - The product does not operate correctly when you follow the operating instructions.
- Do not push any objects into the openings of your system. Doing so can cause fire or electric shock by shorting out interior components.
- Operate the product only from the type of external power source indicated on the electrical ratings label. If you are not sure of the type of power source required, consult your service provider or local power company.

2.3 Mounting the Injector

Desktop Mounting

The injector can be mounted on a desktop or shelf. Make sure there is proper heat dissipation from and adequate ventilation around the device. Do not place heavy objects on the device.

Rack Mounting

The following brackets are designed for use to mount the devices in a 19" rack.

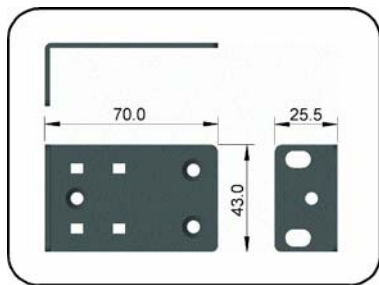

Short Bracket

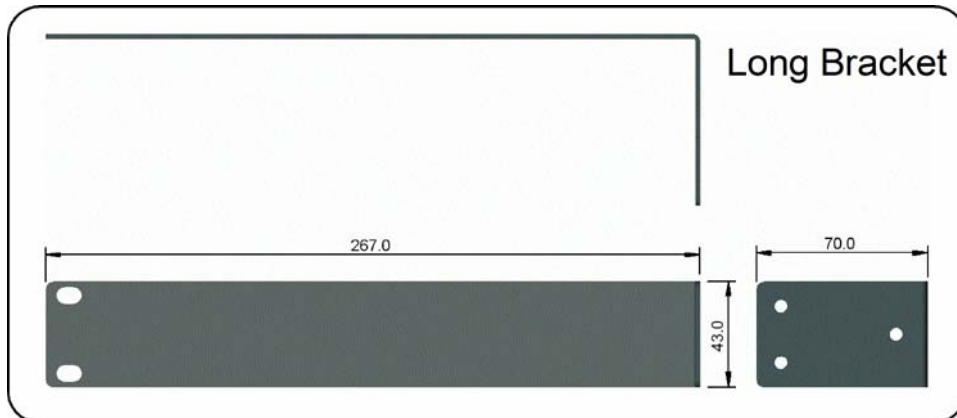

Long Bracket

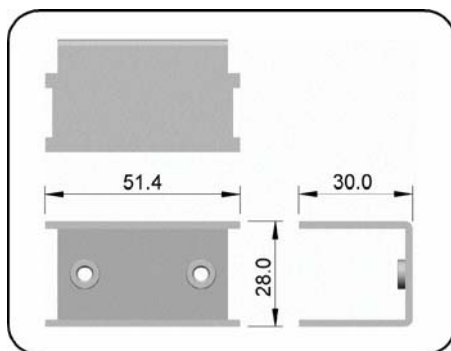

Joint Bracket

Mounting one unit in a rack

Use the bracket set1 and follow the steps shown below:

- ✓ Short bracket x 1
- ✓ Long bracket x 1

1. Install the short bracket to one side of the device.



2. Install the long bracket to the other side of the device.



3. Mount the device in a 19" rack.



Mounting two units in a rack

Use the bracket set 2 and follow the steps shown below:

- ✓ Short bracket x 4
- ✓ Joint bracket x 1

1. Install two short brackets to both sides of each device.

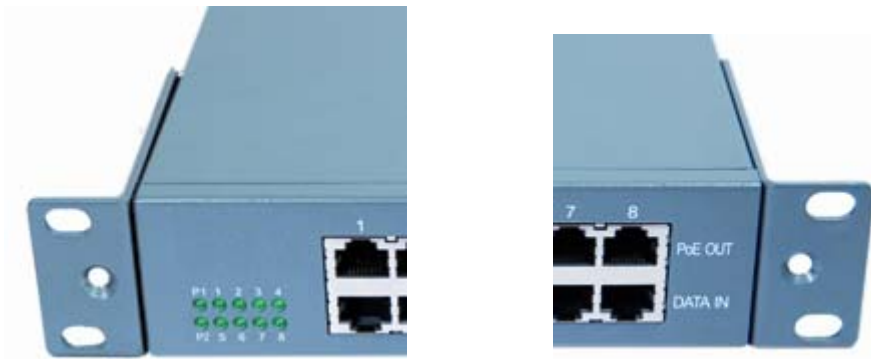

2. Joint two units together as shown below:

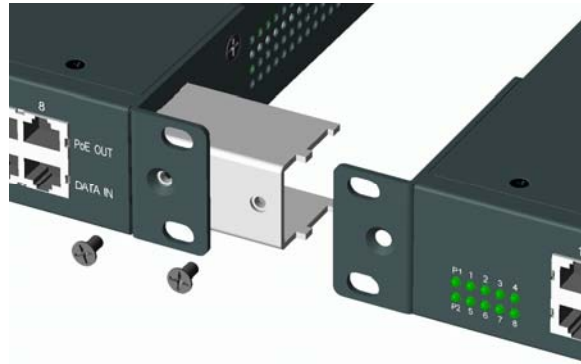

3. Mount two device units as one in a 19" rack.



2.4 Installing Power Module

If you purchased 2 Power Model, you may skip this section. 1 Power Model can deliver total up to 60W for consuming by all eight ports. Calculate the total power budget required for your PD connections before making any connections.

Most of common PoE powered devices such as wireless Access Points, VoIP phones, IP cameras and media converters consume power less than 5Watts. However, refer to the product technical information of individual PD you are using for the power consumption.

If total PoE power more than 60W is required, install one extra power module to the 1 Power injector. The steps are:

1. *Unplug the AC power cord before any installation.*
2. Open the cover of the empty module slot.



3. Install the power module into the slot until it is seated properly.
4. Screw the module in the injector securely.

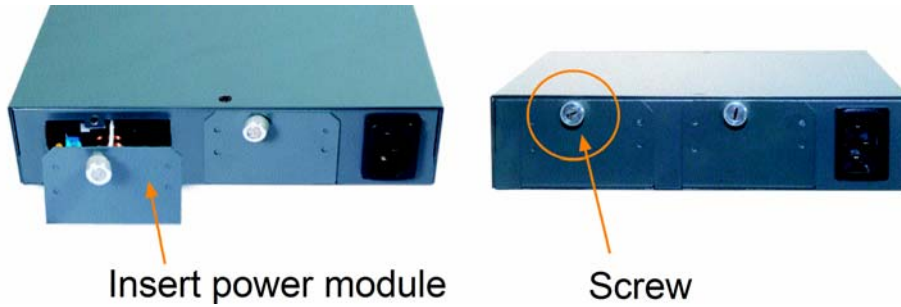

2.5 Applying AC Power

One AC power cord, which meets the specification of your country of origin was supplied with the device unit. The device supports wide range of AC power input specifications as follows:

Specifications

Power Rating: 100 ~ 240VAC, 50/60Hz
 Voltage Range: 90 ~ 264VAC
 Frequency : 47 ~ 63 Hz

Power Consumption

1 Power Model: 68W max. (including 60W for remote PoE PDs)
 2 Power Model: 136W max. (including 120W for remote PoE PDs)

Power Dissipation

1 Power Model: 3W
 2 Power Model: 6W

3. Making LAN Connections

3.1 Making Switch Port Connections

The mid-span injector is designed to support the following PoE incapable switch port types and the PoE function is transparent and independent to the following port configuration:

IEEE 802.3 std.

10BASE-T

100BASE-TX

1000BASE-T

Port Configuration

Auto-negotiation: Enable or disable

Transmission speed: 10Mbps, 100Mbps, 1000Mbps

Duplex: Half duplex, full duplex

Jack Pins: MDI or MDI-X

Network Cables

10BASE-T: 2-pair UTP Cat. 3, 4, 5, EIA/TIA-568B 100-ohm

100BASE-TX: 2-pair / 4-pair UTP Cat. 5, EIA/TIA-568B 100-ohm

1000BASE-T: 4-pair UTP Cat. 5, Cat.5e, Cat.6, EIA/TIA-568B 100-ohm

To make a switch port connection, the steps are:

1. Find an appropriate network cable for a port connection.
2. Connect one end of the cable to the PoE-incapable switch port.
3. Connect the other end to one available DATA IN jack of the PoE injector.

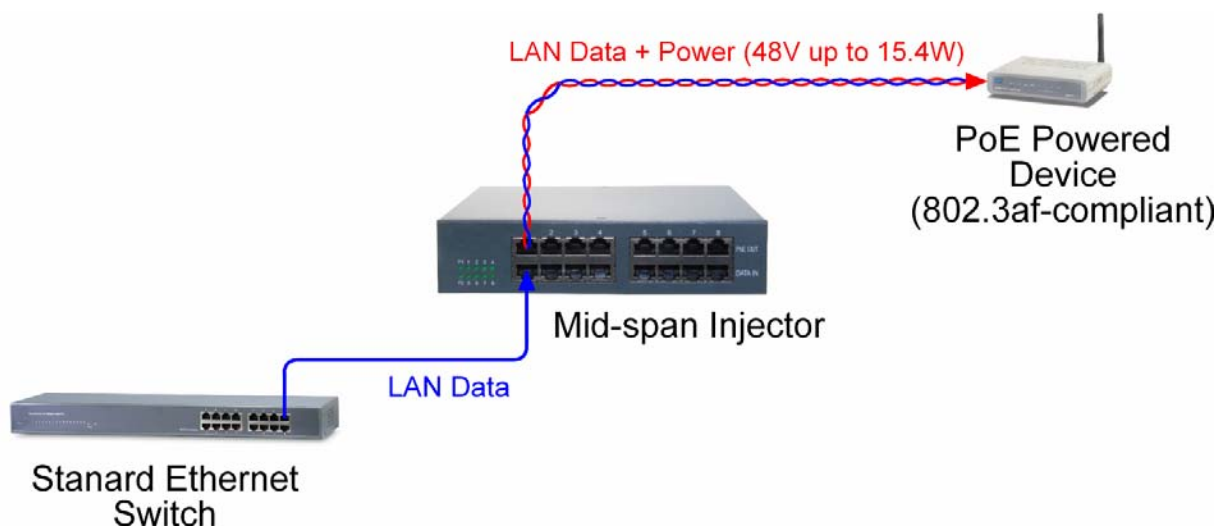

3.2 Making Powered Device Connections

The mid-span injector supports connection to IEEE 802.3af compliant PoE PD (Powered Device). The Ethernet port of the PD can be Ethernet, Fast Ethernet or Gigabit Ethernet. The injector's PoE OUT port delivers power together with network signal to a connected powered device via Cat.5 cable or better.

To make a connection, the following check points should be noted:

1. For safety reason, the connected PD must be a IEEE 802.3af-compliant device. Un-compliant devices are not supported.
2. The Cat.5 cables used for the connections must be 4-pair cables. The power is sent over the pairs (4,5) (7,8) of the cable.
3. Hot-plug connection is allowed anytime.

PoE OUT Port Power

Voltage	48VDC on jack pin 4/5 (V_{48dc+}) and jack pin 7/8 (V_{48dc-})
Power (per port)	15.4W maximum per port
Power (per unit)	1 Power Model - 60W for all 8 PoE OUT ports 2 Power Model - 120W for all 8 PoE OUT ports

Connection Distance

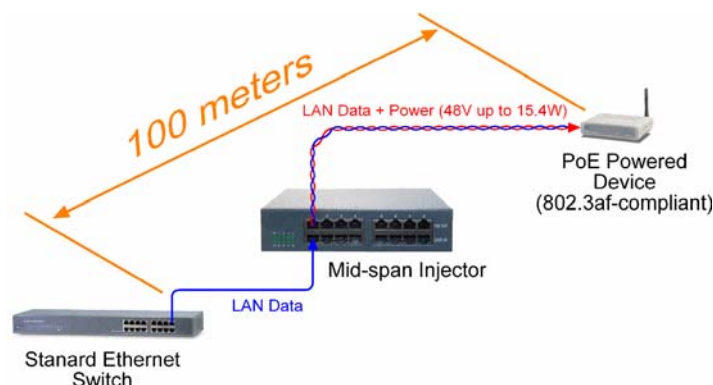

Safety Protection

The injector provides safety protection design for operation. The individual power output of each PoE OUT port is shut down when any of the following events occurs:

Incompliant PD	An incompliant PD is detected on the port.
Disconnection	A PD disconnection.
Overload	An overload situation is detected on the port.
Over-current	An over-current situation is detected on the port.

Short-circuit A short-circuit situation is detected on the port.
Under voltage An under-voltage situation is detected on the port.

3.3 LED Indication

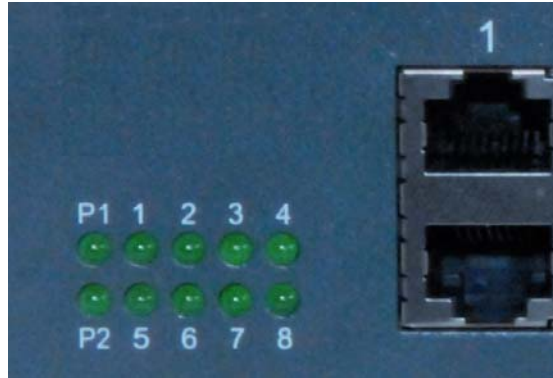

LED	Function	State	Interpretation
P1	Power 1 status	ON	Power 1 is ON.
		OFF	Power 1 is OFF.
P2	Power 2 status	ON	Power 2 is ON.
		OFF	Power 2 is OFF.
1 ~ 8	Port 1 ~ Port 8 PoE status	ON	Port PoE power is ON.
		OFF	Port PoE power is OFF.

4. Applications

4.1 Application with Low Power Requirements

1 Power model may be used if the total power budget of the connected PDs is less than 60Watts. One empty slot can be upgraded with one more power if total power budget increased and is more than 60W in future.

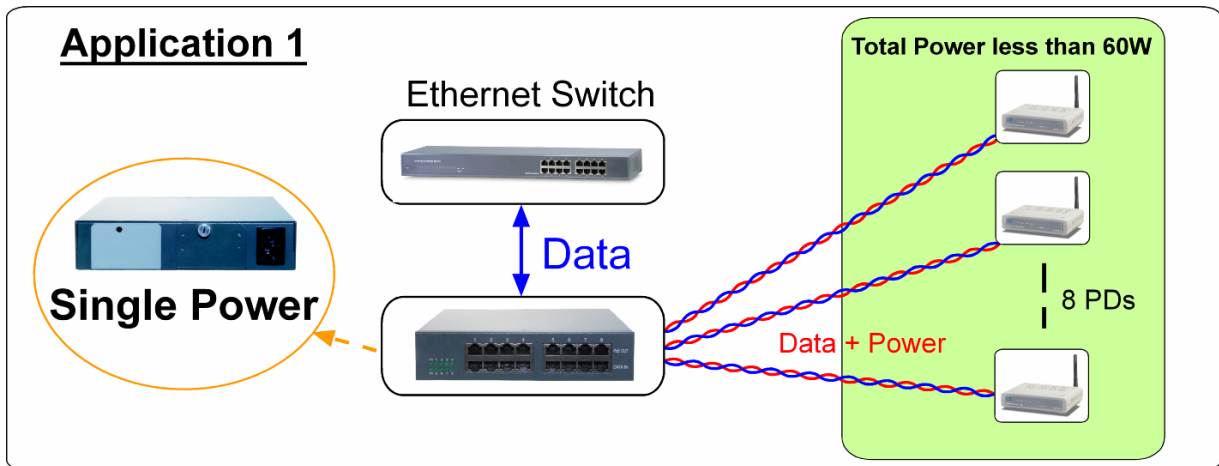

4.2 Application with High Power Requirements

2 Power model can support the total power budget up to 120Watts for all connected PDs.

