



KGS-1064-BP

Industrial Managed

10-Port Gigabit Ethernet Switches

with 2 Dual-speed SFP Slots and 8 PoE PSE Ports

(IEEE 802.3bt PoE)

Firmware Rev1.0 up

User's Manual



DOC.210223A

.(C) 2021 KTI Networks Inc.

All rights reserved. No part of this documentation may be reproduced in any form or by any means or used to make any directive work (such as translation or transformation) without permission from KTI Networks Inc.

KTI Networks Inc. reserves the right to revise this documentation and to make changes in content from time to time without obligation on the part of KTI Networks Inc. to provide notification of such revision or change.

For more information, contact:

15F-7, No. 79, Sec. 1, Hsin-Tai-Wu RD

His-chih, New Taipei City, Taiwan

Fax: 886-2-26983873

E-mail: kti@ktinet.com.tw

URL: <http://www.ktinet.com.tw/>

The information contained in this document is subject to change without prior notice.

Copyright © All Rights Reserved.

TRADEMARKS

Ethernet is a registered trademark of Xerox Corp.

FCC NOTICE

This device complies with Part 15 of the FCC Rules. Operation is subject to the following two conditions: (1)

This device may not cause harmful interference, and (2) This device must accept any interference received, including the interference that may cause undesired operation.

CE NOTICE

Marking by the symbol indicates compliance of this equipment to the EMC directive of the European Community. Such marking is indicative that this equipment meets or exceeds the following technical standards:

EN 61000-6-4

EN 61000-3-2, EN 61000-3-3

EN 61000-6-2

IEC 61000-4-2, IEC 61000-4-3, IEC 61000-4-4

IEC 61000-4-5, IEC 61000-4-6, IEC 61000-4-8

IEC 61000-4-11

EN 50121-4 Certified

EN 50121-1 EMI

EN 61000-6-4

EN 61000-3-2, EN 61000-3-3

EN 50121-4 EMS

EN 61000-4-2, EN 61000-4-3, EN 61000-4-4

EN 61000-4-5, EN 61000-4-6, EN 61000-4-8

EN 61000-4-9

VCCI-A Notice

この装置は、クラスA情報技術装置です。この装置を家庭環境で使用すると電波妨害を引き起こすことがあります。この場合には使用者が適切な対策を講ずるよう要求されることがあります。

VCCI-A

Table of Contents

0B1. Introduction	5
1.1 Features.....	6
1.2 Product Panels.....	7
1.3 LED Indicators.....	8
1.4 Specifications.....	8
1B2. Installation	11
10B2.1 Unpacking.....	11
2.2 Safety Cautions.....	11
12B2.3 DIN-Rail Mounting.....	12
13B2.4 Panel Mounting.....	14
14B2.5 Applying Power.....	16
2.6 Alarm Relay Output.....	17
2.7 Reset Button.....	18
2.8 Making UTP Connections.....	19
2.9 Making Fiber Connection.....	20
2.10 Making PoE PSE Connections.....	22
2.11 LED Indication.....	24
2.12 Making Console Connection.....	25
3. Managing the Switch	26
3.1 IP Address & Password.....	26
3.2 Configuring IP Address & Password via console and telnet.....	26
3.3 Configuring IP Address via Web Interface.....	27
3.4 Reference Manuals for Web, Console, Telnet Management.....	29
3.5 Configuration for SNMP Management.....	30
3.6 SNMP MIBs.....	31
3.6.1 SNMP Traps.....	32
4. Redundant Ring Applications	33
4.1 Auto Multi-Ring Technology.....	33
4.2 Redundant Ring Applications with industrial standard RSTP protocol.....	34

1. Introduction

The KGS-1064-BP is a 10-port industrial managed Gigabit Ethernet switch which is featured with the following communication ports:

- Eight 10/100/1000Mbps Gigabit copper ports with PoE function
- Two dual-speed SFP slots for 100Base-FX 1000Base-X
- One RS-232 console port



1.1 Features

- Eight 10/100/1000Mbps RJ-45 and two dual-speed SFP slots
- All copper ports support auto-negotiation and auto-MDI/MDI-X detection.
- All copper ports are equipped with 802.3bt-compliant PoE PSE function
- Two SFP slots support dual speed for 100BASE-FX and 1000BASE-X SFP transceivers.
- Full wire speed forwarding
- Supports 802.3x flow control for full-duplex and backpressure for half-duplex
- Supports SFP with Digital Diagnostic Monitoring (DDM)
- Provides PoE PSE redundancy function
- Provides fiber Optical Power Alarm (OPA) function
- Provides Automatic Laser Shutdown (ALS) function
- Management:
 - HTTP/HTTPS/SSHv2/CLI telnet/CLI console/SNMP v1/v2c/v3/RMON
 - DHCP/DHCPv6 client, DHCP relay, DNS client, NTPv4
 - IPv6 support, System Syslog, Configuration down/upload, Software upload
- Security:
 - NAS, 802.1X, MAC-based/Web/CLI authentication
 - IP MAC binding, TACACS+, IP source guard
- Layer 2:
 - QoS, 802.1Q/MAC-based/Protocol-based/Private/IP subnet VLAN, Port Isolation
 - Storm control for UC/MC/BC packets, Static MAC configuration
 - IGMP v2/v3 snooping, MLD v1/v2 snooping, DHCP snooping
 - Multiple Spanning Tree - MSTP, RSTP, STP
- Auto Multi-Ring (KAMR) Technology:
 - Fast failover response time
 - Auto recovery when failure is repaired
 - Supports up to five redundant rings
 - Works with RSTP network
- Specific SNMP implementation:
 - Private MIB for reading DDM status
 - Private MIB for remote boot the device over SNMP
 - Private MIB for TFTP firmware update over SNMP
 - Private MIB for configuring OPA function
 - Private MIB for configuring ALS function
 - OPA alarm traps

1.2 Product Panels

The following figure illustrates the front panel and rear panel of the switch:

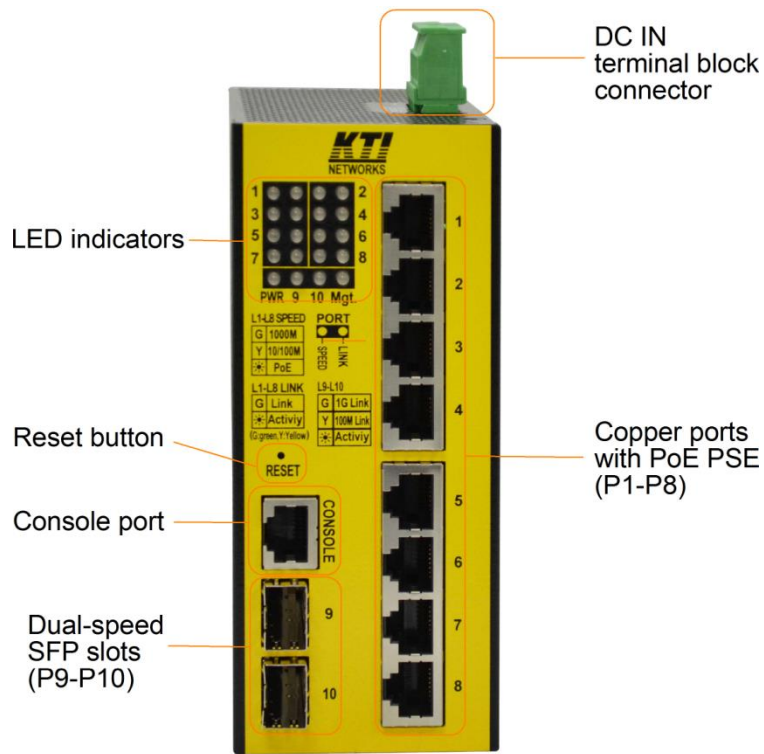

Front panel



DC IN terminal block connector

Top panel

1.3 LED Indicators

<u>LED</u>	<u>Function</u>
PWR	Power status
Mgt.	Management status
Port 1~ 8 SPEED LEDs	Speed & PoE status
Port 1~ 8 LINK LEDs	Link & activity status
SFP 9, 10 LEDs	Speed & link & activity status of SFP port

1.4 Specifications

10/100/1000 Copper Ports (Port 1 ~ Port 8)

Compliance	IEEE 802.3 10Base-T, IEEE 802.3u 100Base-TX, IEEE 802.3u 1000Base-T
Connectors	Shielded RJ-45 jacks
Pin assignments	Auto MDI/MDI-X detection
Configuration	Auto-negotiation or software control
Transmission rate	10Mbps, 100Mbps, 1000Mbps
Duplex support	Full/Half duplex
Network cable	Cat.5 UTP

Dual-speed SFP Slots (Port 9, Port 10)

Compliance	IEEE 802.3u 100Base-FX IEEE 802.3z 1000Base-SX/LX
Connectors	SFP for optional SFP type fiber transceivers
Configuration	Auto 1000Mbps, Full duplex Forced 100Mbps, Full duplex
Transmission rate	100Mbps and 1000Mbps
Network cables	MMF 50/125 μ m 62.5/125 μ m, SMF 9/125 μ m
Eye safety	IEC 825 compliant

Console Port

Interface	RS-232, DTE type, galvanic isolation
Connector	Shielded RJ-45

Switch Functions

MAC Addresses Table	8K entries
Forwarding & filtering	Non-blocking, full wire speed
Switching technology	Store and forward

Maximum packet length 9.6K bytes
 IP Multicast groups 8192 supported
 Flow control IEEE 802.3x pause frame base for full duplex operation
 Back pressure for half duplex operation

Power over Ethernet PSE Function

PSE Ports Port 1 ~ Port 8
 Standard IEEE 802.3af, IEEE 802.3at, and IEEE 802.3bt
 PD classes support PSE port output vs. PD input

Compliant PD classes	IEEE std.			DC power min. *1	PSE output power max. *2	Cable power pairs	PD Available power min. *3
	802.3af	802.3at	802.3bt				
Class 1	√	√	√	45V	5.3W	2	3.84W
Class 2	√	√	√	45V	8.5W	2	6.49W
Class 3	√	√	√	45V	19W	2	13W
Class 4		√	√	45V	36W	4	25.5W
Class 5			√	51V	51W	4	40W
Class 6			√	51V	68W	4	51W
Class 7			√	53V	83W	4	62W
Class 8			√	53V	95W	4	71.3W

*1: The minimum DC power voltage to support the specified PSE output
 *2: The maximum output power at the PSE end for the requested PD class
 *3: The minimum power received at the PD end with maximum output at the PSE end in worst case

Power Delivery 95W max. (per port) at port output for Cat.5 distance up to 100 meters
 PSE power pins Pin 1/2/4/5: V_{poe+}, Pin 3/6/7/8: V_{poe-} (V_{poe} comes from DC power input)
 Protection PoE output shutdown
 Protection events Incompliant PD detection, PD disconnection
 Overload, Over-current, Short-circuit, Under voltage
 Power Capacity 240W shared by all PSE ports

Terminal Block Connector

DC power input Screwed euro terminal block: DC +/- contacts
 Operating Input Voltages +12 ~ +60VDC for general applications
 +45 ~ +57VDC for PoE applications
 Power consumption 10.3W max. (Full load with no PSE output)
 250.3W max. (with full PoE output)
 Alarm relay output 3 terminal contacts (30VDC/1A max. or 120VAC/0.5A max.)

NC contacts: normal – shored, alarm – open
NO contacts: normal – open, alarm – shored
Alarm events Power failure, Specific port link fault (software configured), OPA

Mechanical

Dimension 140 x 106 x 60 mm (HxDxW)
Housing Enclosed metal with no fan
Mounting Din-rail mounting, Panel mounting (optional)

Environmental

Operating Temperature Typical -30°C ~ +70°C
Storage Temperature -40°C ~ +85°C
Relative Humidity 5% ~ 95% non-condensing

Electrical Approvals

FCC Part 15 rule Class A
CE EN 61000-6-4, EN 61000-6-2 EMC
VCCI Class A
Safety / LVD IEC 62368-1
EN 50121-4 EMC for railway applications

2. Installation



2.1 Unpacking

The product package contains:

- The switch unit
- QR code label
- One console cable

2.2 Safety Cautions

To reduce the risk of bodily injury, electrical shock, fire and damage to the product, observe the following precautions:

	Do not service any product except as explained in your system documentation.	
	Opening or removing covers may expose you to electrical shock.	
	Only a trained service technician should service components inside these compartments.	
	<p>If any of the following conditions occur, unplug the product from the electrical outlet and replace the part or contact your trained service provider:</p> <ul style="list-style-type: none"> - The power cable, extension cable, or plug is damaged. - An object has fallen into the product. - The product has been exposed to water. - The product has been dropped or damaged. - The product does not operate correctly when you follow the operating instructions. 	
	Do not push any objects into the openings of your system. Doing so can cause fire or electric shock by shorting out interior components.	
	Operate the product only from the type of external power source indicated on the electrical ratings label. If you are not sure of the type of power source required, consult your service provider or local power company.	
		<p>Since the surface temperature of the device may be higher than 70°C in range of the rated operating temperatures, install and operate the product only by authorized personnel only. Install the product at a restricted area where un-authorized persons cannot reach.</p>

2.3 DIN-Rail Mounting

In the product package, a DIN-rail bracket is provided for mounting the switch in a industrial DIN-rail enclosure.

The steps to mount the switch onto a DIN rail are:

1. Install the mounting bracket onto the switch unit as shown below:

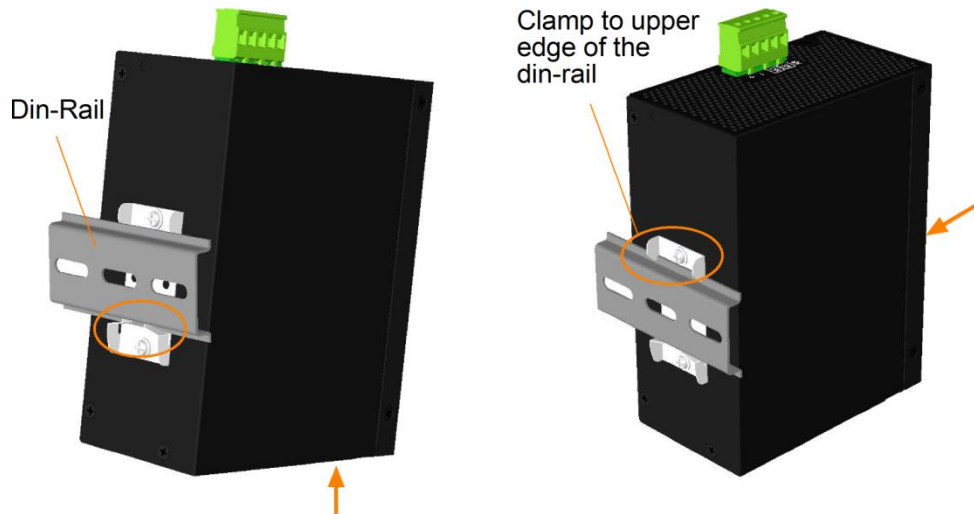

2. Attach bracket to the lower edge of the DIN rail and push the unit upward a little bit until the bracket can clamp on the upper edge of the DIN rail.
3. Clamp the unit to the DIN rail and make sure it is mounted securely.

Dimensions:

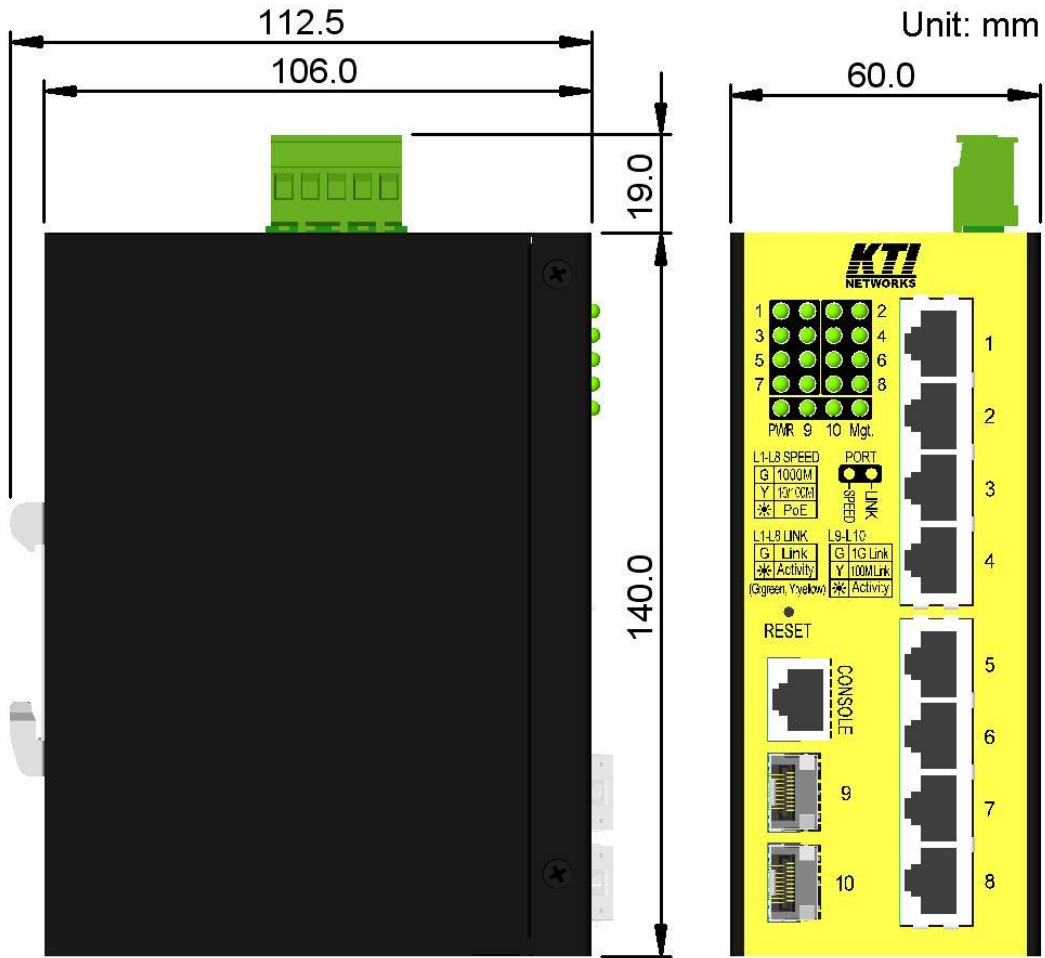

2.4 Panel Mounting

The switches are provided with an optional panel mounting bracket. The bracket supports mounting the switch on a plane surface securely.

The mounting steps are:

1. Install the mounting bracket on the switch unit.

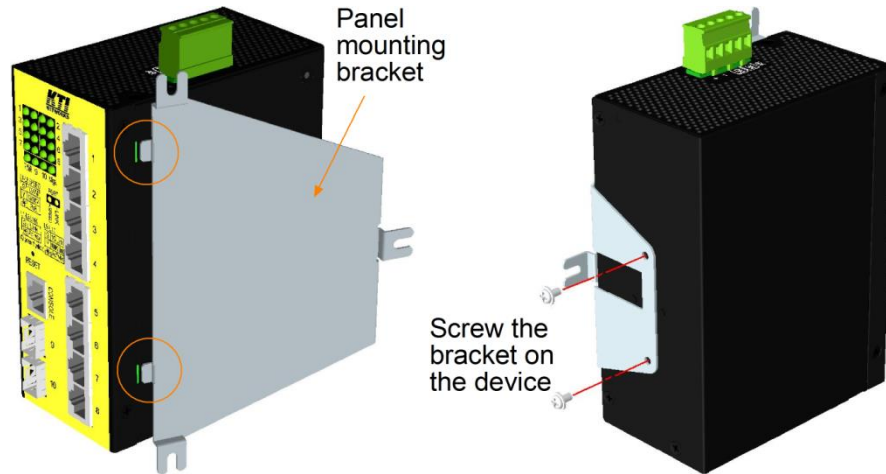

2. Screw the bracket on the switch unit.
3. Screw the switch unit on a panel. Three screw locations are shown below:

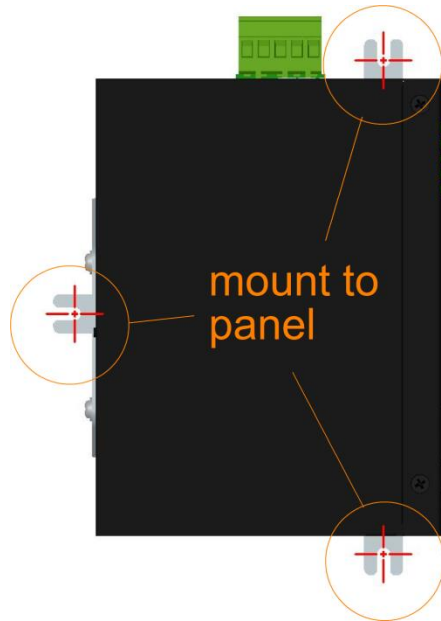

Dimensions:

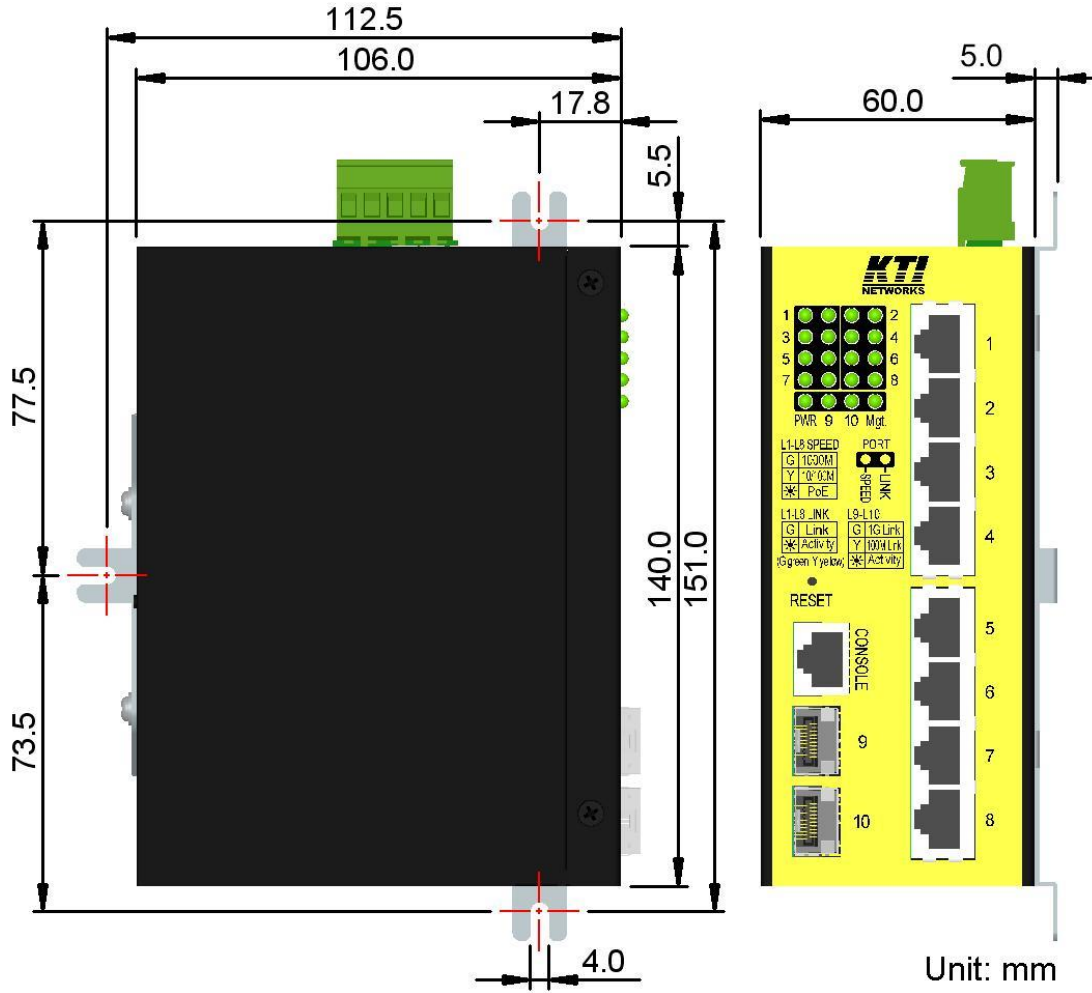

2.5 Applying Power

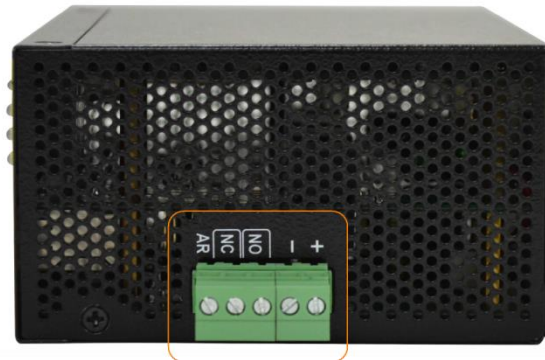

DC IN terminal block connector

Power pins of the terminal block connector

Pin	1	+	Vdc Positive (+) input terminal
	2	-	Vdc Negative (-) input terminal

Vdc Input specifications

Working voltage range	Applications	Power output at PSE port
+12V ~ +60VDC	General	-
+45V ~ +57VDC	PoE, PoE+	+51V, 36W max.
+53V ~ +57VDC	PoE++	+53V, 95W max.

A 2P terminal plug is provided together with the switch as shown below:



Power wires : 24 ~ 12AWG (IEC 0.5~2.5mm²), 1 meter max.

2.6 Alarm Relay Output

Alarm relay output is provided for reporting failure events to a remote alarm relay monitoring system. The relay output is provided with three contacts (support two logic types) in the terminal block connector next to Vdc interfaces.

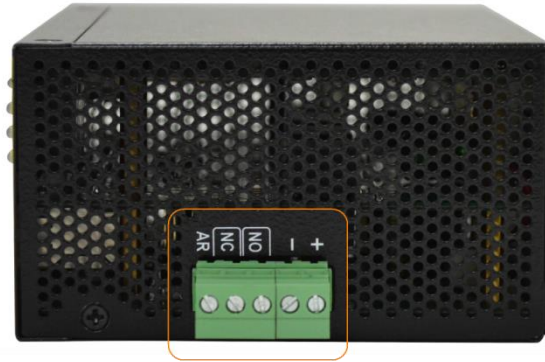

DC IN terminal block connector

Alarm Relay output pins and logic:

Pin	3	4	Alarm relay output, NO (Normal Open) contacts
	NO		Open: Normal, Shorted: Alarm
Pin	4	5	Alarm relay output, NC (Normal Closed) contacts
	NC		Shorted: Normal, Open: Alarm

Either pair can be used depending on the logic requirement for the relay monitoring system. Use the provided 3P terminal plug for signal wiring and plug into the contacts.

Alarm Events

- Input power failure
- Specific port link down (The specific ports can be configured by software.)
- OPA alarm if optical power is higher than a upper limit setting or lower than a lower limit setting

Note: Be sure the voltage applied on the contacts is within the specification of 30VDC/1A max. or 120VAC/0.5A max.

2.7 Reset Button

The reset button is used to perform a reset to the switch. It is not used in normal cases and can be used for diagnostic purpose. If any network hanging problem is suspected, it is useful to push the button to reset the switch without turning off the power. Check whether the network is recovered.

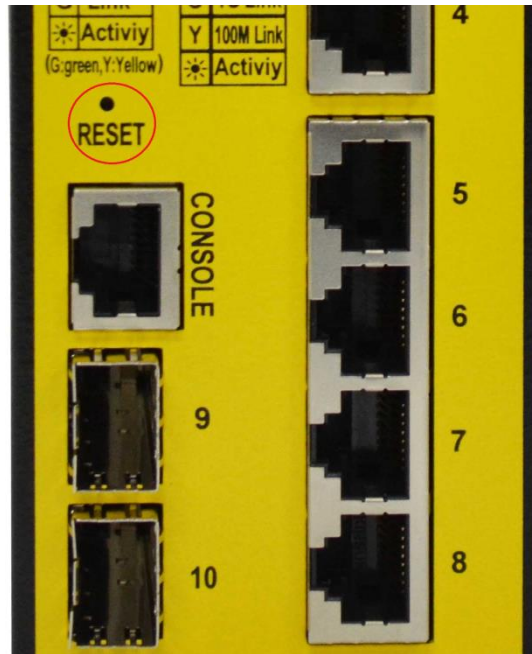

The button can also be used to restore the software configuration settings to factory default values.

The operations are:

Operation	Function
Press the button and release during switch operation	Reset & boot up the switch. The boot-up takes about 20 seconds and ends with all LED yellow ON and green ON then all OFF once.
Press the button until all LED yellow ON and green ON, then all OFF.	Boot & restore all factory default settings

2.8 Making UTP Connections

The 10/100/1000 RJ-45 copper ports support the following connection types and distances:

Network Cables

10BASE-T:	2-pair UTP Cat. 3, 4, 5 , EIA/TIA-568B 100-ohm
100BASE-TX:	2-pair UTP Cat. 5, EIA/TIA-568B 100-ohm
1000BASE-T:	4-pair UTP Cat. 5 or higher (Cat.5e is recommended), EIA/TIA-568B 100-ohm
Link distance:	Up to 100 meters for all above

Auto MDI/MDI-X Function

This function allows the port to auto-detect the twisted-pair signals and adapts itself to form a valid MDI to MDI-X connection with the remote connected device automatically. No matter a straight through cable or crossover cable is connected, the ports can sense the receiving pair automatically and configure itself to match the rule for MDI to MDI-X connection. It simplifies the cable installation.

Auto-negotiation Function

The ports are featured with auto-negotiation function and full capability to support connection to any Ethernet devices. The port performs a negotiation process for the speed and duplex configuration with the connected device automatically when each time a link is being established. If the connected device is also auto-negotiation capable, both devices will come out the best configuration after negotiation process. If the connected device is incapable in auto-negotiation, the switch will sense the speed and use half duplex for the connection.

Port Configuration Management

For making proper connection to an auto-negotiation incapable device, it is suggested to use port control function via software management to set forced mode and specify speed and duplex mode which match the configuration used by the connected device.

2.9 Making Fiber Connection

The dual-speed SFP slots, Port 9 and Port 10 must be installed with an SFP fiber transceiver for making fiber connection. The switch may come with one or two SFP transceivers pre-installed when it is shipped.

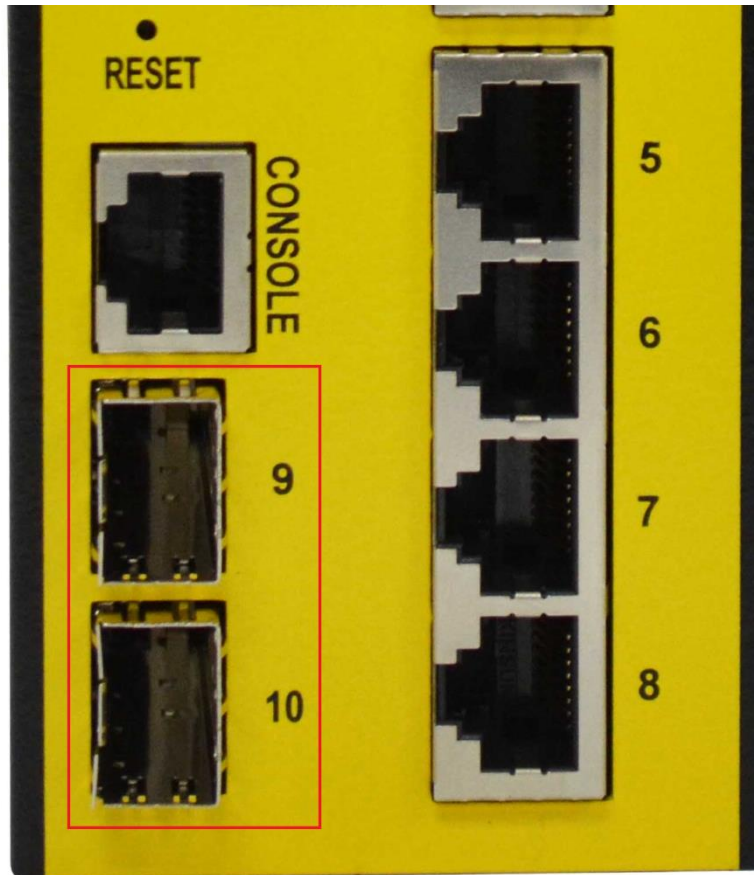

Types of the SFP Fiber transceivers supported:

1000Mbps based 1000BASE-X SFP transceivers

100Mbps based 100BASE-FX SFP transceivers

Installing SFP Fiber Transceiver

To install an SFP fiber transceiver into SFP slot, the steps are:

1. Turn off the power to the switch.
2. Insert the SFP fiber transceiver into the SFP slot. Normally, a bail is provided for every SFP transceiver. Hold the bail and make insertion.
3. Until the SFP transceiver is seated securely in the slot, place the bail in lock position.

Connecting Fiber Cables

LC connectors are commonly equipped on most SFP transceivers. Identify TX and RX connector

before making cable connection. The following figure illustrates a connection example between two fiber ports:

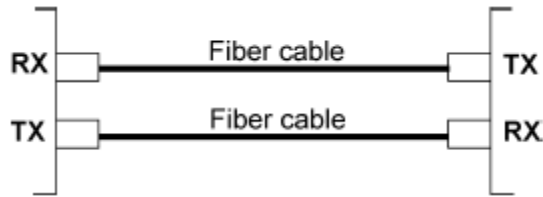

Make sure the Rx-to-Tx connection rule is followed on the both ends of the fiber cable.

Network Cables

Multimode (MMF) - 50/125 μ m, 62.5/125 μ m

Single mode (SMF) - 9/125 μ m

Port Speed Configuration

There are three options for configuring port speed via software for SFP Port 9 and Port 10.

The options are:

Port Mode	Description
Auto	Auto-detection for the type of the installed SFP transceiver by reading DDM data 100Mbps transceiver: Non-auto-negotiation (forced), 100Mbps, full duplex 1000Mbps transceiver: Auto-negotiation, 1000Mbps, full duplex
100Mbps FDX	Non-auto-negotiation (forced), 100Mbps, full duplex
1Gbps FDX	Auto-negotiation, 1000Mbps, full duplex

2.10 Making PoE PSE Connections

This section describes how to make a connection between a PSE port and a PoE Powered D device (PD). All copper ports are equipped with PoE PSE function. The ports are enabled to deliver power together with network signal to a connected powered device via Cat.5 cable. To make a PoE connection, the connected PoE PD must be a IEEE 802.3af IEEE 802.3at or IEEE 802.3bt-compliant device for safety reason. Incompliant devices are not supported by the PoE switch model. The following table lists the power levels of IEEE 802.3 standard:

IEEE 802.3 standard: PoE Classification for the Compliant PD Types and Power Level

Compliant PD classes	IEEE std.			PSE output power max.	PD available power min.
	802.3af	802.3at	802.3bt		
Class 1	√	√	√	4W	3.84W
Class 2	√	√	√	7W	6.49W
Class 3	√	√	√	15.4W	13W
Class 4		√	√	32W	25.5W
Class 5			√	45W	40W
Class 6			√	60W	51W
Class 7			√	75W	62W
Class 8			√	90W	71.3W

RJ-45 Pin Assignments of the device's PSE Port

Pin	PoE power	1000Base-T	10/100Base-TX
1	V_{poe+}	BI_DB+	RX+
2	V_{poe+}	BI_DB-	RX-
3	V_{poe-}	BI_DA+	TX+
4	V_{poe+}	BI_DD+	-
5	V_{poe+}	BI_DD-	-
6	V_{poe-}	BI_DA-	TX-
7	V_{poe-}	BI_DC+	-
8	V_{poe-}	BI_DC-	-

V_{poe} : PoE power voltage on TP port

The PSE ports are equipped with the following capabilities:

1. Detection for an IEEE 802.3af /802.3at/802.3bt compliant PD.
2. No power is supplied to a device which is classified non-IEEE 802.3 compliant PD.
3. No power is supplied when no connection exists on the port.

4. The power is cut off immediately from powering condition when a disconnection occurs.
5. The power is cut off immediately from powering condition when overload occurs.
6. The power is cut off immediately from powering condition when over-current occurs.
7. The power is cut off immediately from powering condition when short circuit condition occurs.

The device specifications: DC power input vs. PoE power output

Requested PD classes	DC power min. *1	PSE output power max. *2	Cable power pairs *3	PD available power min. *4
Class 1	45 ~ 57V	5.3W	2	3.84W
Class 2	45 ~ 57V	8.5W	2	6.49W
Class 3	45 ~ 57V	19W	2	13W
Class 4	45 ~ 57V	36W	4	25.5W
Class 5	51 ~ 57V	51W	4	40W
Class 6	51 ~ 57V	68W	4	51W
Class 7	53 ~ 57V	83W	4	62W
Class 8	53 ~ 57V	95W	4	71.3W

*1: The minimum DC power voltage to support the specified maximum PSE output

*2: The maximum output power at the PSE end for the requested PD class

*3: Cable pairs that deliver PSE power

*4: The minimum power received at the PD end with maximum output at the PSE end in worst case

*5: The maximal total power budget shared by all PSE ports of the device is 240W.

Connection example:

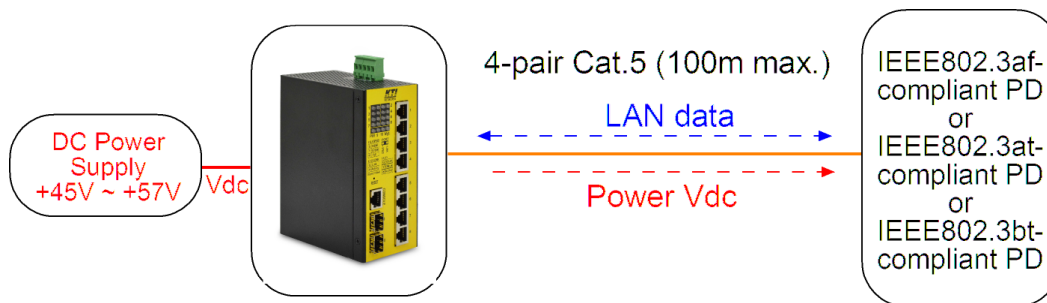

2.11 LED Indication

LED	Function	Color	State	Interpretation
PWR	Power status	Green	ON	The power is supplied to the switch.
			OFF	The power is not supplied to the switch.
Mgt	Management status	Green	OFF	The switch is in initialization and diagnostics.
		Yellow	BLINK	Initialization completed with diagnostic error
		Green	ON	Initialization completed with no error
Port1 ~ Port 8				
SPEED_LED	Port speed status	Green	ON	Speed is 1000Mbps.
		Yellow	ON	Speed is 10Mbps or 100Mbps.
			BLINK	PoE power is on.
LINK_LED	Port link status	Green	ON	Port link is established. (No traffic)
		Green	BLINK	Port link is up and there is traffic.
			OFF	Port link is down.
Port 9, Port 10				
Speed_LED	Port speed/link status	Green	ON	A 1000Mbps link is established.
		Yellow	ON	A 100Mbps link is established.
			BLINK	Activity status
			OFF	Port link is down.

2.12 Making Console Connection

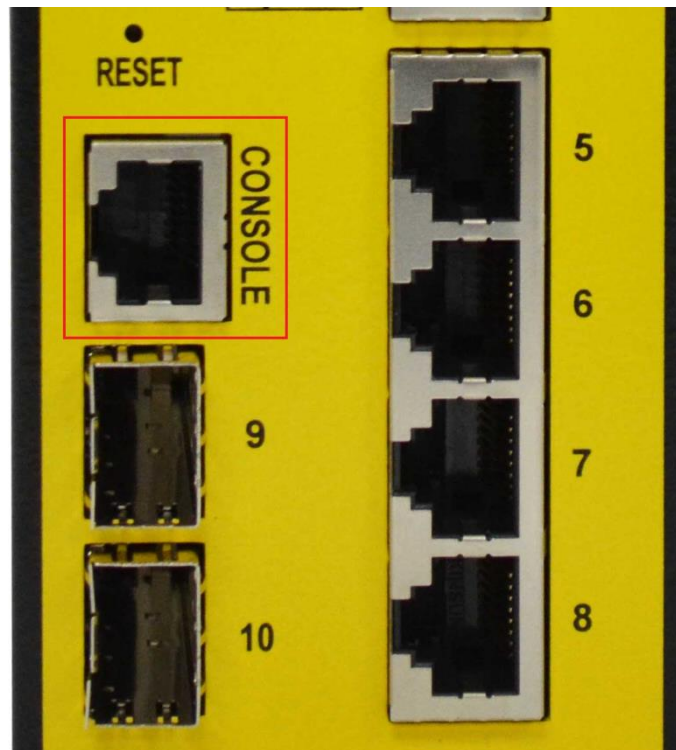

The connector designed for the console port is RJ-45.

Pin Assignments

Pin	RS-232 signals	IN/OUT
1, 2, 7, 8	NC	
3	RxD	IN
6	TxD	OUT
4, 5	GND	

Baud Rate information

Baud rate - 115200

Data bits - 8

Parity - None

Stop bit - 1

Flow control – None

3. Managing the Switch

The switch provides the following methods to configure and monitor the switch as follows:

- Making out of band telnet CLI management via the console port
- Making in-band management via telnet CLI over TCP/IP network
- Making in-band management via web interface over TCP/IP network
- Making in-band SNMP management over TCP/IP network

3.1 IP Address & Password

The IP Address is an identification of the switch in a TCP/IP network. Each switch should be designated a new and unique IP address in the network. The switch is shipped with the following factory default settings for software management:

Default IP address of the switch: **192.168.0.2 / 255.255.255.0**

The switch uses local authentication instead of RADIUS authentication with factory defaults.

Fixed Username: **admin**

Default password:

No password is required with factory default. However, the password is used for local authentication in accessing to the switch via console, telnet and Http web-based interface. For security reason, it is recommended to change the default settings for the switch before deploying it to your network.

3.2 Configuring IP Address & Password via console and telnet

[IP Address] setting command is in IP command group.

```
>IP Setup [<ip_addr>] [<ip_mask>] [<ip_router>] [<vid>]
```

Parameters:

```
<ip_addr>      : IP address (a.b.c.d)  
<ip_mask>     : IPv4 subnet mask (a.b.c.d)  
<ip_router>   : IPv4 router (a.b.c.d)  
<vid>         : VLAN ID (1-4095)
```

[IPv6 Address] setting command is also in IP command group.

```
>IP IPv6 Setup [<ipv6_addr>] [<ipv6_prefix>] [<ipv6_router>]
```

Parameters:

- <ipv6_addr> : IPv6 address is in 128-bit records represented as eight fields of up to four hexadecimal digits with a colon separates each field (:).
- <ipv6_prefix> : IPv6 subnet mask
- <ipv6_router> : IPv6 router

[Password] setting command is also in Security/Switch/Users command group.

Security Switch Users Configuration

Security Switch Users Add <user_name> <password> <privilege_level>

Security Switch Users Delete <user_name>

Refer to “Operation manual for telnet and console management”.

3.3 Configuring IP Address via Web Interface

Start Web Browser

Start your browser software and enter the default IP address of the switch unit to which you want to connect. The IP address is used as URL for the browser software to search the device.

URL: <http://192.168.0.2/>

Login to Switch Unit

When browser software connects to the switch unit successfully, a Login screen is provided for you to login to the device as the left display below:



Enter the following default values in the login page:

Default username: *admin*

Default password: ↵

No password is required.

Click to login into the switch.

Web Page after a Successful Login

KTI NETWORKS

KGS-1064-BP GigaBit Ethernet Switch

Port State Overview Auto-refresh

- ▶ Configuration
- ▼ Monitor
 - ▶ System
 - Thermal Protection
 - ▼ Ports
 - State
 - Traffic Overview
 - QoS Statistics
 - QCL Status
 - Detailed Statistics
 - ▶ Security
 - ▶ LACP
 - Loop Protection
 - ▶ Spanning Tree
 - ▶ MVR
 - ▶ IPMC
 - ▶ LLDP
 - PoE
 - MAC Table
 - ▶ VLANs
 - sFlow
 - Multi Ring Status
 - Relay Alarm Status
- ▶ Diagnostics
- ▶ Maintenance

Select [Configuration] -> [System] -> [IP] to configure IP address

IP Configuration

	Configured	Current
DHCP Client	<input type="checkbox"/>	<input type="button" value="Renew"/>
IP Address	192.168.0.179	192.168.0.179
IP Mask	255.255.255.0	255.255.255.0
IP Router	0.0.0.0	0.0.0.0
VLAN ID	1	1
DNS Server	0.0.0.0	0.0.0.0

IP DNS Proxy Configuration

DNS Proxy

Configuration **Description**

DHCP Client	Enable the DHCP client by checking this box.
IP Address	Provide the IP address of this switch unit.
IP Mask	Provide the IP mask of this switch unit.
IP Router	Provide the IP address of the default router for this switch unit.
VLAN ID	Provide the managed VLAN ID. The allowed range is 1 through 4095.
DNS Server	Provide the IP address of the DNS Server in dotted decimal notation.
DNS Proxy	When DNS proxy is enabled, DUT will relay DNS requests to the current configured DNS server on DUT, and reply as a DNS resolver to the client device on the network.

<input type="button" value="Save"/>	Click to save the changes.
<input type="button" value="Reset"/>	Click to undo any changes made locally and revert to previously saved values.
<input type="button" value="Renew"/>	Click to renew DHCP. This button is only available if DHCP is enabled.

3.4 Reference Manuals for Web, Console, Telnet Management

The following operation manuals are also provided separately for Console, Telnet and Web management:

Operation manual - telnet & console management xxxxxx.doc

Operation manual - web management xxxxx.doc

The manuals describe the detailed commands and information.

3.5 Configuration for SNMP Management

The switch supports SNMP v1, SNMP v2c, and SNMP v3 management. Make sure the related settings are well-configured for the switch before you start the SNMP management from an SNMP manager.

Using Telnet Interface

The following are available commands in telnet SNMP command group to configure SNMP-related settings:

```
>SNMP Configuration
>SNMP Mode [enable/disable]
>SNMP Version [1/2c/3]
>SNMP Read Community [<community>]
>SNMP Write Community [<community>]
>SNMP Trap Mode [enable/disable]
>SNMP Trap Version [1/2c/3]
>SNMP Trap Community [<community>]
>SNMP Trap Destination [<ip_addr_string>]
>SNMP Trap IPv6 Destination [<ipv6_addr>]
>SNMP Trap Authentication Failure [enable/disable]
>SNMP Trap Link-up [enable/disable]
>SNMP Trap Inform Mode [enable/disable]
>SNMP Trap Inform Timeout [<timeout>]
>SNMP Trap Inform Retry Times [<retries>]
>SNMP Trap Probe Security Engine ID [enable/disable]
>SNMP Trap Security Engine ID [<engineid>]
>SNMP Trap Security Name [<security_name>]
>SNMP Engine ID [<engineid>]
>SNMP Community Add <community> [<ip_addr>] [<ip_mask>]
>SNMP Community Delete <index>
>SNMP Community Lookup [<index>]
>SNMP User Add <engineid> <user_name> [MD5/SHA] [<auth_password>] [DES] [<priv_password>]
>SNMP User Delete <index>
>SNMP User Changekey <engineid> <user_name> <auth_password> [<priv_password>]
>SNMP User Lookup [<index>]
>SNMP Group Add <security_model> <security_name> <group_name>
>SNMP Group Delete <index>
>SNMP Group Lookup [<index>]
>SNMP View Add <view_name> [included/excluded] <oid_subtree>
```

>SNMP View Delete <index>
>SNMP View Lookup [<index>]
>SNMP Access Add <group_name> <security_model> <security_level> [<read_view_name>] [<write_view_name>]
>SNMP Access Delete <index>
>SNMP Access Lookup [<index>]

Using Web Interface

Select [Configuration] -> [Security] -> [SNMP]:



The commands supports configuration for:

- Basic system configuration for SNMP v1 and SNMP v2c
- Basic system configuration for SNMP v1 trap, SNMP v2c trap and SNMP v3 trap
- Communities that permit to access to SNMPv3 agent
- USM (User-based Security Model) user table for SNMPv3
- VACM (View-based Access Control Model) Viewer table for SNMPv3
- Group table for SNMPv3
- Accesses group table for SNMPv3

3.6 SNMP MIBs

The switch provides the following SNMP MIBs:

- RFC 1213 - MIB II
- RFC 2674 - QBridge MIB (VLAN MIB)
- RFC 2819 - RMON (Group 1, 2, 3 & 9)
- RFC 2863 - Interface Group (IF) MIB
- RFC 3411 - SNMP Management Frameworks
- RFC 3414 - User Based Security Model (USM)
- RFC 3415 - View Based Access Control Model (VACM)
- RFC 3621 - Power Ethernet MIB
- RFC 3635 - EtherLike MIB
- RFC 3636 - 802.3 Medium Attachment Units (MAUs) MIB
- RFC 4133 - Entity MIB

- RFC 4188 - Bridge MIB
- RFC 4668 - RADIUS Authentication Client MIB
- RFC 5519 - Multicast Group Membership Discovery (MGMD) MIB
- IEEE 802.1 MSTP MIB
- IEEE 802.1AB LLDP MIB
- IEEE 802.1X Port Access Entity (PAE) MIB
- TIA 1057 LLDP Media Endpoint Discovery (MED) MIB
- IEEE 802.1-Q-BRIDGE MIB
- Private SFPDDM MIB (Read DDM status of the SFP ports)
- Private reboot MIB (Remote boot over SNMP)
- Private TFTP firmware update MIB (TFTP Firmware update over SNMP)
- Private OPA function MIB (OPA configuration for the SFP ports)
- Private ALS function MIB (ALS configuration for the SFP ports)

One product MIB file is also available in the product CD for SNMP manager software.

3.6.1 SNMP Traps

In addition to the SNMP standard traps, the device is equipped with private OPA alarm traps.

The traps are:

- Alarm trap – Port TX power lower than the minimal value
- Alarm trap – Port TX power higher than the maximal value
- Normal trap – Port TX power back to normal (higher than the minimal value)
- Normal trap – Port TX power back to normal (lower than the maximal value)

4. Redundant Ring Applications

4.1 Auto Multi-Ring Technology

Auto Multi-Ring Technology was developed especially for switches connected in ring topology which needs redundant support when any failure occurs in ring. For large network, more than one ring connections are very common. Auto Multi-Ring Technology implementation can support more than one ring connection within a switch. It is also able to work with RSTP support concurrently in the switch.

Some basic information is:

- Supports up to five rings in one switch
- Supports up to 30 member switches in one ring
- Provides fast response time than RSTP protocol
- Works with RSTP protocol concurrently within one switch

The following figure illustrates a configuration that three redundant rings and one RSTP ring hook on a main redundant ring. Some switches support two redundant rings concurrently.

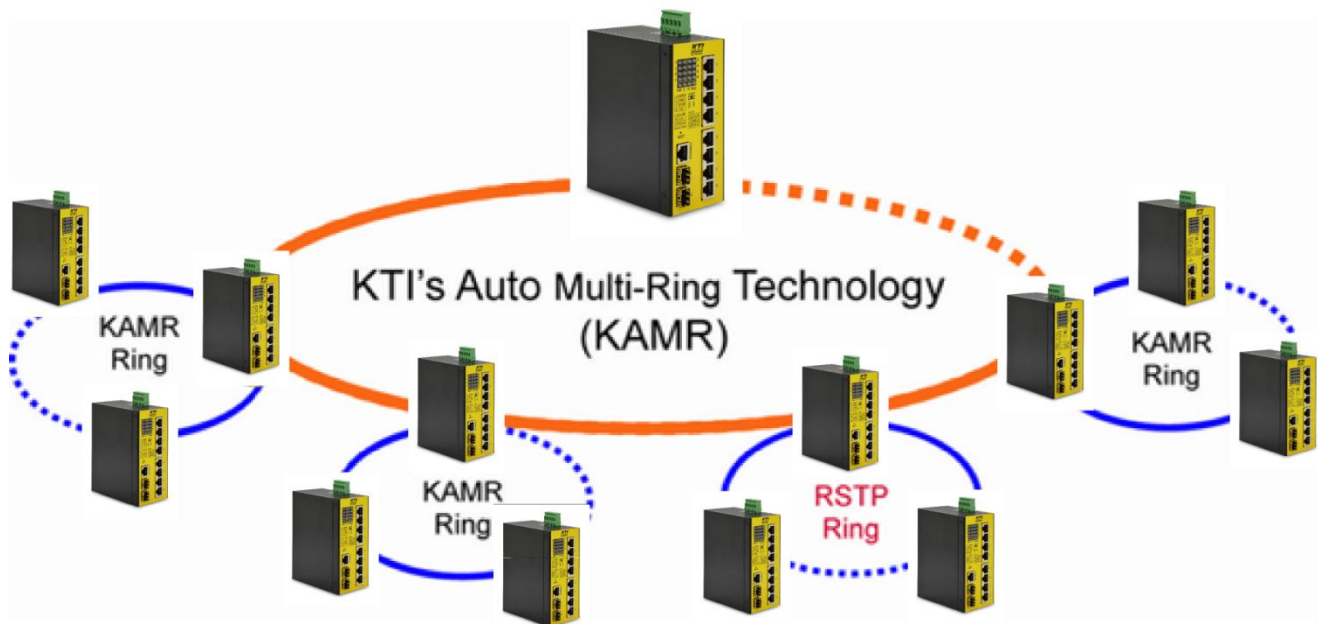

The following figure shows one switch is configured to support three redundant rings and one RSTP ring at the same time.

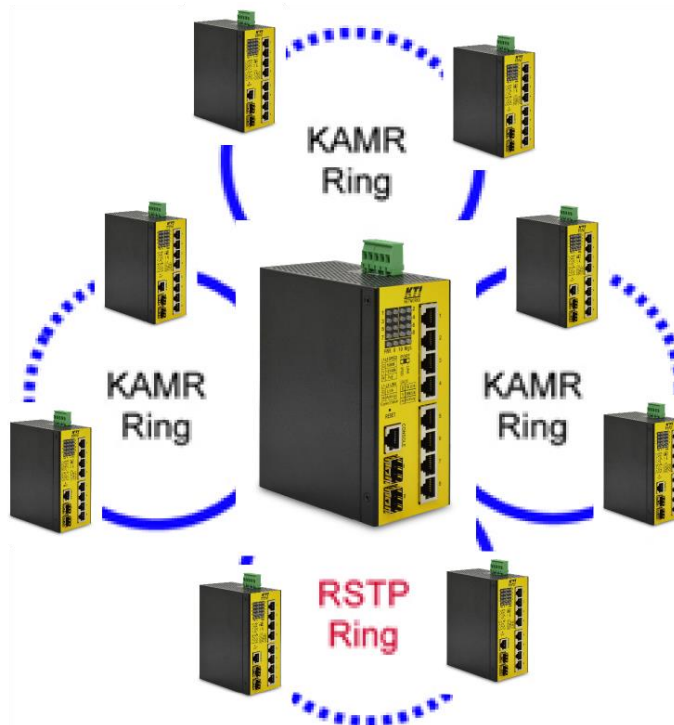

4.2 Redundant Ring Applications with industrial standard RSTP protocol

It also can be done to support a ring connection using industrial standard RSTP function and establish a backup path. In case that any link failure occurs, the backup path can link up immediately to recover the network operation.