



KGS-2461-S

KGS-2461-HP

Industrial Managed 24-Port L2/L3
Gigabit Ethernet Switches with PoE+ features

Installation Guide



DOC.160817

(C) 2016 KTI Networks Inc. All rights reserved. No part of this documentation may be reproduced in any form or by any means or used to make any derivative work (such as translation or transformation) without permission from KTI Networks Inc.

KTI Networks Inc. reserves the right to revise this documentation and to make changes in content from time to time without obligation on the part of KTI Networks Inc. to provide notification of such revision or change.

For more information, contact:

For more information, contact:

15F-7, No. 79, Sec. 1, Hsin-Tai-Wu Rd.

Hsi-chih, New Taipei City, Taiwan

Fax: 886-2-26983873

E-mail: kti@ktinet.com.tw

URL: <http://www.ktinet.com.tw/>

The information contained in this document is subject to change without prior notice.
Copyright (C) All Rights Reserved.

TRADEMARKS

Ethernet is a registered trademark of Xerox Corp.

FCC NOTICE

This device complies with Part 15 of the FCC Rules. Operation is subject to the following two conditions: (1) This device may not cause harmful interference, and (2) This device must accept any interference received, including the interference that may cause undesired operation.

CE NOTICE

Marking by the symbol indicates compliance of this equipment to the EMC directive of the European Community. Such marking is indicative that this equipment meets or exceeds the following technical standards:

CISPR 22

EN 61000-6-4

EN61000-6-2

Table of Contents

1. Introduction.....	5
1.1 Features.....	6
1.2 Product Panels.....	10
1.3 LED Indicators	10
1.4 Specifications.....	10
2. Installation.....	14
2.1 Unpacking.....	14
2.2 Safety Cautions.....	14
2.3 Mounting the Switch.....	15
2.4 Applying AC Power Supply (KGS-2461-S)	16
2.5 Applying DC Power Supply (KGS-2461-HP).....	17
2.6 Reset Button	18
2.7 Making UTP Connections	18
2.8 Making SFP Fiber Connection	19
2.9 Making PoE PSE Connections (KGS-2461-HP)	21
2.10 LED Indication.....	22
2.11 Making Console Connection	23
2.12 Alarm Relay Output.....	24
3. Managing the Switch.....	25
3.1 IP Address & Password	25
3.2 Configuring IP Address via console and telnet CLI.....	25
3.3 Configuring Local Authentication via console and telnet CLI	26
3.4 Configuring IP Address & Password via Web Interface	27
3.5 Reference Manuals for Web, Console, Telnet Management	31
3.6 Configuration for SNMP Management	32
3.7 SNMP MIBs	33

1. Introduction

The industrial-rated 24-port Managed Gigabit Ethernet Switches are standard L2 & L3 switches that meets all IEEE 802.3/u/x/z Gigabit, Fast Ethernet specifications. They are featured with the following switched ports and advantages in a 1U rack box:

- 20 10/100/1000Mbps Gigabit copper ports
- 4 combo ports - 10/100/1000Mbps copper & dual-speed SFP
- One RS-232 Console port
- Optional PoE+ PSE function on all copper ports

The switches support Telnet CLI, Web GUI, SNMP and console CLI interface for switch management. The network administrator can logon the switch to monitor and configure port operating mode, Quality of Service, and powerful L2 switching functions such as VLAN, IGMP, RSTP etc. In addition, the switches are also featured with powerful security functions such as SSH, HTTPS, IEEE 802.1x & MAC-based authentication, and ACL control to make them suitable for industrial core applications.



Model Definition

Model No.	Model	Power Input	Power connector	PoE+ feature
KGS-2461-S	AC powered model	AC 100 ~ 240V	IEC320	No
KGS-2461-HP	DC powered model	DC +/-40~57V	Screw terminals (Redundant input)	Yes

1.1 Features

- Provide 24 10/100/1000Mbps RJ-45 and four dual speed SFP slots (4 combo ports)
- Provide optional 24 802.3at compliant PoE+ PSE ports
- All copper ports support auto-negotiation and auto-MDI/MDI-X detection
- The SFP slots support both 100BASE-X and 1000BASE-X SFP transceivers
- Support SFP with Digital Diagnostic Monitoring (DDM) support
- Provide L2 switching at Gigabit full wire speed
- Provide L3 switching functions for IPv4/IPv6 Unicast routing and IPv4 Multicast routing
- Support Green Ethernet power saving
- Support 802.3x flow control for full-duplex and backpressure for half-duplex
- Jumbo frame support up to 10056 frame length
- Support 802.1Q VLAN and diversified VLAN functions
- Provide QoS function
- Support port bandwidth control for ingress and egress
- Support packets storm control function for broadcast, unicast and multicast
- Support LACP port link aggregation
- Support MAC address learning, ageing and filtering control
- Provide port mirroring function
- Provide Optical Power Alarm (OPA) function
- Provide Auto Laser Shutdown (ALS) function
- 19" rack mountable
- Both AC powered model and DC powered model are available for choice.
- Redundant DC power input
- Relay alarm output for port link faults, power failure, and fiber OPA alarm

Management Features:

- Port Control
 - Port Speed/Duplex Mode/Flow Control/Power saving configuration
 - Port frame size control (Jumbo frame support)
- QoS
 - Traffic Classification up to 8 active priorities
 - Port QoS configuration
 - QoS Control List for policy rules
 - Port bandwidth control for ingress and egress
 - Storm Control for UC, MC and Unknown MAC
 - Port ingress bandwidth policer
 - Policers for ACL rules



- Port egress bandwidth shaper
- Queue egress bandwidth shaper
- DiffServ (RFC2474) DSCP based classification and remarking
- Tag based remarking
- Port scheduler mode for egress queue
- Layer2
 - Auto MAC address learning and ageing
 - Static MAC address filtering
 - 802.1Q VLAN
 - VLAN trunking
 - LAN Trunking
 - Multiple Registration Protocol – MRP
 - IEEE-802.1ad Provider Bridge (Native or Translated VLAN)
 - Link Aggregation - LACP
 - MSTP, RSTP, STP
 - Port Mirroring
 - IGMP, MLD snooping
 - DHCP client for IP configuration
- Layer 3 Switching
 - DHCP option 82 relay
 - UPNP
 - IPv4 Unicast: Static routing
 - IPv4 Unicast: RIPv1/RIPv2
 - IPv4 Multicast Routing
 - IPv6 Unicast Routing
- Security features
 - Port-based 802.1X
 - Single 802.1X
 - Multiple 802.1X
 - MAC-based authentication
 - ADIUS Accounting
 - MAC Address Limit
 - MAC address limit by VLAN
 - MAC Freeze - All learned MAC addresses on specified ports become static MAC addresses
 - MAC Spoofing - Network protection against changing MAC address to bypass the ACL services
 - IP MAC binding
 - IP/MAC binding dynamic to static

- TACACS+ Protocol for authenticating users that wish to manage the switch.
- TACACS+ Accounting
- Web & CLI Authentication
- User Authorization Levels for CLI and Web management.
- Web-based Authentication
- Authorization (15 user levels)
- ACLs for filtering/policing/port copy
- Access Control Lists for filtering, policing or port copy
- IP source guard - Access Control List for L2/L3 protocol filtering, ingress rate limit, port copy
- Management
 - DHCP Client
 - DHCPv6 Client
 - DHCP Server
 - DNS client, proxy
 - HTTP Server - Web management
 - Console CLI
 - Telnet CLI
 - Industrial Standard CLI
 - Industrial Standard Configuration
 - Management access filtering
 - HTTPS
 - SSHv2
 - System Syslog
 - Software Upload via web
 - SNMP v1 / v2c / v3 Agent
 - RMON (Group 1, 2, 3 & 9)
 - SNMP trap group
 - Link Layer Discovery – LLDP
 - LLDP-MED
 - sFlow
 - Software Download via Web
 - Configuration download and upload
- SNMP MIBs
- Specific features
 - Port Link Alarm
 - PoE
 - OPA

- ALS
- SFP DDM

1.2 Product Panels

The following figure illustrates the front panel and rear panel of the switch:

Model	Front & Rear
AC powered model	
DC powered model	

1.3 LED Indicators

<u>LED</u>	<u>Function</u>
POWER	Power status
Mngt	Management status
1000M	Port speed status, PoE status
Link/Act.	Port link and activity status (Port 1 – Port 24)
PAF, PBF	Power fault status (KGS-2461-HP)

1.4 Specifications

10/100/1000 Copper Ports (Port 1 ~ Port 24)

Compliance	IEEE 802.3 10Base-T, IEEE 802.3u 100Base-TX, IEEE 802.3u 1000Base-T
Connectors	Shielded RJ-45 jacks
Pin assignments	Auto MDI/MDI-X detection
Configuration	Auto-negotiation or software control
Transmission rate	10Mbps, 100Mbps, 1000Mbps
Duplex support	Full/Half duplex
Network cable	Cat.5 UTP

Power over Ethernet PSE Function (Model KGS-2461-HP only)

PSE Ports	Port 1 ~ Port 24
Power output pins	Positive of power voltage: pin 4,5 Negative of power voltage: pin 7,8
Standard	IEEE 802.3at
Classification	PD Class 0 ~ 4 detection
Power Delivery	30W max. at port output for Cat.5 distance up to 100 meters
Output Voltage	Same as DC IN voltage
Protection	Under voltage protection Over voltage protection Over current detection

Dual-speed SFP Slots (Port 21 ~ Port 24)

Compliance	IEEE 802.3z 1000BASE-SX/LX (mini-GBIC) IEEE 802.3u 100BASE-FX
Connectors	SFP slot supports optional both 100M and 1000M SFP type fiber transceivers
Configuration options	Auto-negotiation 1000Mbps Full duplex Forced 100Mbps Full duplex (Software configurable)
Network cables	MMF 50/125 μ m 60/125 μ m, SMF 9/125 μ m
Eye safety	IEC 825 compliant

Alarm Relay Output

Interface	6 dry contacts
Connector	European terminal block
Alarm Events	Power fault, Port link down, Fiber alarm

Console Port

Interface	RS-232, DTE type
Connector	9-pin D-sub

Switch Functions

MAC Addresses Table	8K entries
Forwarding & filtering	Non-blocking, full wire speed
Switching technology	Store and forward
Maximum packet length	10056 bytes (Jumbo frame support)
Flow control	IEEE 802.3x pause frame base for full duplex operation Back pressure for half duplex operation
VLAN function	Port-based VLAN and IEEE 802.1Q Tag-based VLAN
VLAN support	4096 VLANs (IEEE 802.1Q)
Aggregation	LACP Port link aggregation (port trunking)
QoS function	Ethernet type, IP-based, DSCP, TOS-based, VID-based, VLAN Tag-based packet classification Port rate control, storm control
Port Mirroring	Mirror received frames to a sniffer port

AC Power Input (AC powered models)

Interfaces	IEC320 receptacle
Operating Input Voltages	100 ~ 240VAC / 0.26-0.13A
Power Consumption	27W max.

DC Power Input (DC powered models)

Interfaces	Redundant screw-type terminal block
Input Voltages	+40 ~ +57VDC for non-PoE applications +45 ~ +57VDC for supporting PoE/PoE+ applications +51 ~ +57VDC for supporting PoE+ 30W PDs Polarity reversal protection
Power Consumption	770W max. including full PoE load on all ports Current 16A max. @+48VDC 30W max. (No PoE consuming)
Rated input wire	AWG10~12

Mechanical

Dimension (base)	443 x 280 x 43 mm (WxDxH)
Housing	Enclosed metal

Mounting Desktop mounting, 19" rack mounting

Environmental

Operating Temperature Typical -30°C ~ +60°C
Storage Temperature -40°C ~ +85°C
Relative Humidity 10% ~ 90% non-condensing

Certificates & Approvals

FCC Part 15 Subpart B, Class A
VCCI:2005-04 Japan Emission std. , Class A
CE mark European Conformity
LVD Safety
IEC60950-1 Safety standard
CISPR22 Class A
EN 61000-6-4 Emission for industrial environments
EN61000-6-2 Immunity for industrial environments
EN 50121-1 EMC standard for railway applications - general
EN 50121-4 EMC standard for railway applications - telecommunication apparatus
IEC 60068-2-64 Vibration
IEC 60068-2-27 Shock 20G

2. Installation

2.1 Unpacking

The product package contains:

- The switch unit
- One AC power cord (AC powered Model)
- One 19" rack mounting kit
- One product CD-ROM
- One RS-232 serial cable

2.2 Safety Cautions

To reduce the risk of bodily injury, electrical shock, fire and damage to the product, observe the following precautions.

	Do not service any product except as explained in your system documentation.
	Opening or removing covers may expose you to electrical shock.
	Only a trained service technician should service components inside these compartments.
	If any of the following conditions occur, unplug the product from the electrical outlet and replace the part or contact your trained service provider: <ul style="list-style-type: none">- The power cable, extension cable, or plug is damaged.- An object has fallen into the product.- The product has been exposed to water.- The product has been dropped or damaged.- The product does not operate correctly when you follow the operating instructions.
	Do not push any objects into the openings of your system. Doing so can cause fire or electric shock by shorting out interior components.
	Operate the product only from the type of external power source indicated on the electrical ratings label. If you are not sure of the type of power source required, consult your service provider or local power company.

2.3 Mounting the Switch

Desktop Mounting

The switch can be mounted on a desktop or shelf. Make sure that there is proper heat dissipation from and adequate ventilation around the device. Do not place heavy objects on the device.

Rack Mounting

Two 19-inch rack mounting brackets are supplied with the switch for 19-inch rack mounting.

The steps to mount the switch onto a 19-inch rack are:

1. Turn the power to the switch off.
2. Install two brackets with supplied screws onto the switch as shown in figure below.



3. Mount the switch onto 19-inch rack with rack screws securely.



4. Turn the power to the switch on.

2.4 Applying AC Power Supply (KGS-2461-S)

If the purchased switch is with AC power input, one AC power cord which meets the specification of your country of origin was supplied in package. Before installing AC power cord to the switch, make sure the AC power is OFF and the AC power to the power cord is turned off.



AC power input specifications

Connector: IEC320 type

Power Rating: 100 ~ 240VAC, 50/60Hz

Current Rating: 0.26 ~ 0.13A

Voltage Range: 90 ~ 264VAC

Frequency: 47 ~ 63 Hz

Power Consumption: 27W max.

Important Notes:

- 1. The socket-outlet shall be installed near the switch and shall be easily accessible.*
- 2. Use of an approved power supply cord not lighter than IEC 60227, H03VV-F, 3G, 0.75mm² or alternatively IEC 60245, H05RR-F, 3G, 0.75mm².*

2.5 Applying DC Power Supply (KGS-2461-HP)

If the purchased switch is with DC power input, the power connector is shown below. It provides two power input interfaces, POWER A and POWER B. Each comes with one connector and one power switch. The design supports power redundancy to the device.



DC power input specifications

Receptacle: Screw-type terminal block

Voltages: +40 ~ +72VDC

Polarity reversal protection

Power Consumption: 30W max. @ 48VDC when no PoE consumption

Power Consumption: 770W including full PoE load on all ports

Contacts

⊕ Vdc+ input

⊖ Vdc- input

⊥ Protective earth (Connected chassis and isolated with Vdc+ & Vdc-)

Working voltage range Application

+40 ~ +57VDC

General with no PoE

+45 ~ +57VDC

Supporting general PoE/PoE+ PDs

+51 ~ +57VDC

Supporting PoE+ PDs consuming more than 30W

2.6 Reset Button



The reset button is used to perform a reset to the switch. It is not used in normal cases and can be used for diagnostic purpose. If any network hanging problem is suspected, it is useful to push the button to reset the switch without turning off the power. Check whether the network is recovered.

The button can also be used to restore the software configuration settings to factory default values. The operations are:

Operation	Function
Press the button during system boot-up and release it after boot-up. The boot-up takes about 27 seconds and ends with LED diagnostics.	Restore factory default settings
Press the button and release during switch operation	Re-boot the switch unit

The operations are:

Operation	Function
Press the button and release during switch operation	Reset & boot up the switch. The behavior is same as power boot procedure.
Press the button until MGT-LED steady ON	Boot & restore all factory default settings

2.7 Making UTP Connections

The 10/100/1000 RJ-45 copper ports support the following connection types and distances:

Network Cables

10BASE-T: 2-pair UTP Cat. 3, 4, 5, EIA/TIA-568B 100-ohm

100BASE-TX: 2-pair UTP Cat. 5, EIA/TIA-568B 100-ohm

1000BASE-T: 4-pair UTP Cat. 5 or higher (Cat.5e is recommended), EIA/TIA-568B 100-ohm

Link distance: Up to 100 meters

Auto MDI/MDI-X Function

This function allows the port to auto-detect the twisted-pair signals and adapts itself to form a valid MDI to MDI-X connection with the remote connected device automatically. No matter a straight through cable or crossover cable are connected, the ports can sense the receiving pair automatically and configure themselves to match the rule for MDI to MDI-X connection. It simplifies the cable installation.

Auto-negotiation Function

The ports are featured with auto-negotiation function and full capability to support connection to any Ethernet devices. The port performs a negotiation process for the speed and duplex configuration with the connected device automatically when each time a link is being established. If the connected device is also auto-negotiation capable, both devices will come out the best configuration after negotiation process. If the connected device is incapable in auto-negotiation, the switch will sense the speed and use half duplex for the connection.

Port Configuration Management

For making proper connection to an auto-negotiation INCAPABLE device, it is suggested to use port control function via software management to set forced mode and specify speed and duplex mode which match the configuration used by the connected device.

2.8 Making SFP Fiber Connection

The dual-speed SFP slots, F21 ~ F24 must be installed with an SFP fiber transceiver for making fiber connection. The switch may come with one or two SFP transceivers pre-installed when it is shipped.



Types of the SFP Fiber transceivers supported:

1000Mbps based 1000BASE-X SFP transceivers

100Mbps based 100BASE-FX SFP transceivers

Installing SFP Fiber Transceiver

To install an SFP fiber transceiver into SFP slot, the steps are:

1. Turn off the power to the switch.
2. Insert the SFP fiber transceiver into the SFP slot. Normally, a bail is provided for every SFP transceiver. Hold the bail and make insertion.
3. Until the SFP transceiver is seated securely in the slot, place the bail in lock position.

Connecting Fiber Cables

LC connectors are commonly equipped on most SFP transceivers. Identify TX and RX connector before making cable connection. The following figure illustrates a connection example between two fiber ports:

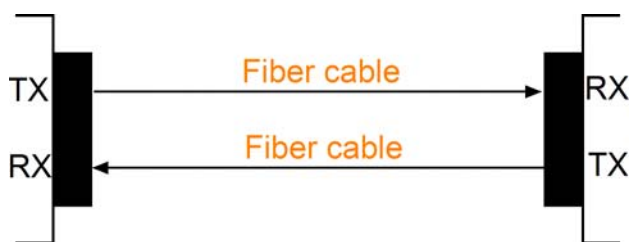

Make sure the Rx-to-Tx connection rule is followed on the both ends of the fiber cable.

Network Cables

Multimode (MMF) - 50/125, 62.5/125

Single mode (SMF) - 9/125

Port Speed Configuration

There are three options for configuring port speed via software for SFP Port 9 and Port 10.

The options are:

Port Mode	Description
Auto	Auto-detection for the type of the installed SFP transceiver by reading DDM data 100Mbps transceiver: Non-auto-negotiation (forced), 100Mbps, full duplex 1000Mbps transceiver: Auto-negotiation, 1000Mbps, full duplex
100Mbps FDX	Non-auto-negotiation (forced), 100Mbps, full duplex
1Gbps FDX	Auto-negotiation, 1000Mbps, full duplex

2.9 Making PoE PSE Connections (KGS-2461-HP)

This section describes how to make a connection between a PSE port and a PoE Powered D device (PD). All copper ports are equipped with PoE PSE function. The ports are enabled to deliver power together with network signal to a connected powered device via Cat.5 cable. To make a PoE connection, the connected PoE PD must be a IEEE 802.3af or IEEE 802.3at-compliant device for safety reason. Incompliant devices are not supported by the PoE switch model.

RJ-45 Pin Assignments of PSE Port

Pin	PoE power	1Gbps LAN signal	100Mbps LAN signal
1		BI_DB+	RX+
2		BI_DB-	RX-
3		BI_DA+	TX+
4	V_{poe+}	BI_DD+	-
5	V_{poe+}	BI_DD-	-
6		BI_DA-	RX-
7	V_{poe-}	BI_DC+	-
8	V_{poe-}	BI_DC-	-

The PSE ports are equipped with the following capabilities:

1. Detection for an IEEE 802.3af /802.3at compliant PD.
2. No power is supplied to a device which is classified non-IEEE 802.3af compliant PD.
3. No power is supplied when no connection exists on the port.
4. The power is cut off immediately from powering condition when a disconnection occurs.
5. The power is cut off immediately from powering condition when overload occurs.
6. The power is cut off immediately from powering condition when over-current occurs.
7. The power is cut off immediately from powering condition when short circuit condition occurs.

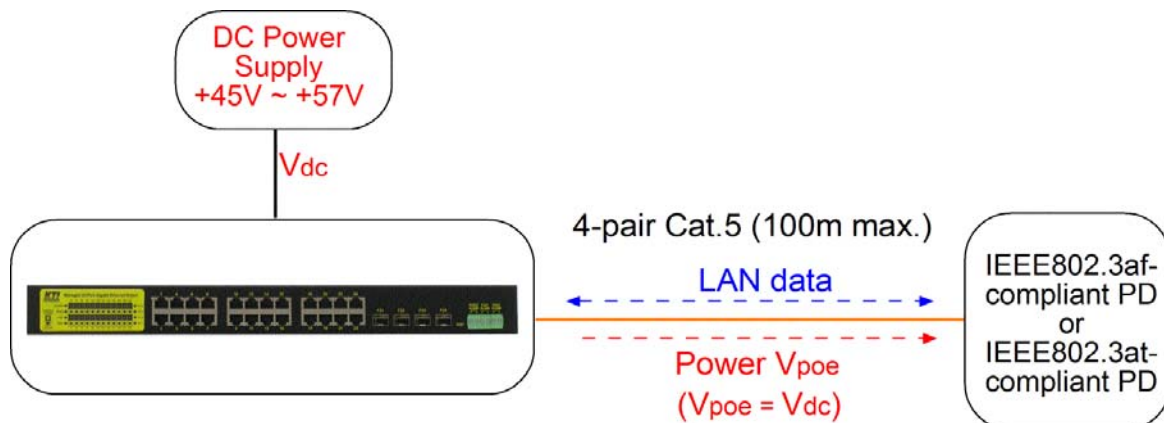

2.10 LED Indication

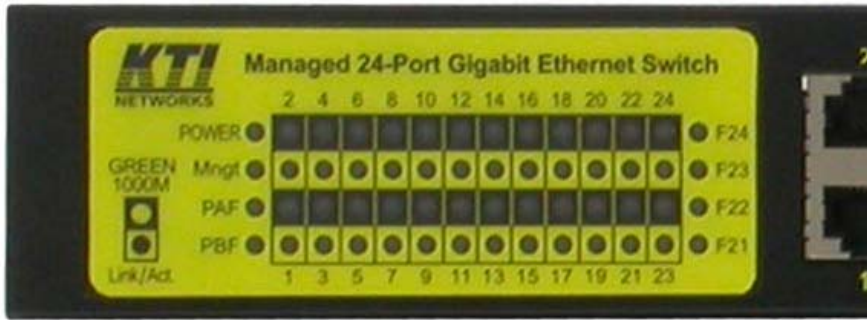

Name	Function	State	Color	Interpretation
POWER	Power status	ON	Green	Power is supplied to the device.
PAF	POWER A status	ON	Amber	DC POWER A input failed.
		OFF	--	DC POWER A input normal
PBF	POWER B status	ON	Amber	DC POWER B input failed.
		OFF	--	DC POWER B input normal
Mngt	Management	OFF	--	The switch is in initialization and diagnostics.
		ON	Green	The switch is initialized completely and normal.
		Blink	Green	The switch is initialized completely with diagnostic error.
1000M	Speed / PoE	Blink	Green	1000Mbps + PoE ON
		ON	Green	1000Mbps
		Blink	Amber	10/100Mbps + PoE ON
		ON	Amber	10/100Mbps
Link/Act	Link & activity	ON	Green	Port link ON & no traffic
		OFF	--	Port link down
		Blink	Green	Port Activity
Fx	Fiber	ON	Green	Fiber is selected.
		OFF	--	Copper is selected.

2.11 Making Console Connection



Console port is an isolated DB9 connector. It serves as an RS-232 DTE port.

Pin Definitions

Pin 2 RXD
Pin 3 TXD
Pin 5 GND
Pin 1,4,6-9 NC

Use simple RS232 null modem without handshaking to connect the console port to PC's DB9 COM port as follows:

<u>Console Pins</u>		<u>COM Port Pins</u>	
Pin 2	RXD	Pin 3	TXD
Pin 3	TXD	Pin 2	RXD
Pin 5	GND	Pin 5	GND

Baud Rate Information

Baud rate: 115200
Data bits: 8
Parity: none
Stop bit: 1
Flow control: disabled

2.12 Alarm Relay Output

Three alarm relay outputs are equipped on the front panel. They provide relay output for reporting the device's alarm events to the remote relay monitoring system.

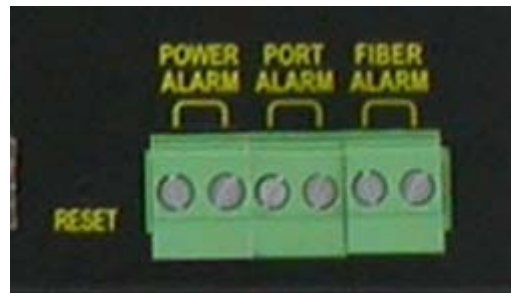

Three Relay Outputs

There are three alarm outputs to indicate three different types of alarms. They are:

1. Power alarm
2. Port alarm
3. Fiber alarm

Output Logic

Each relay output has two terminal contacts. The alarm logic of two contacts:

CLOSE	Normal status
OPEN	Alarm event occurs.

Alarm Events

Relay Output	Alarm Events	
Power Alarm	Power fault	DC Power A fault (It can be disabled via software interfaces.) DC Power B fault (It can be disabled via software interfaces.) AC power loss System power failure
Port Alarm	Port link fault	Specific port link down (The specific ports can be configured via software interfaces.)
Fiber Alarm	Optical power fault	Fiber port OPA alarm if optical power is higher than a upper limit setting or lower than a lower limit setting (The specific ports can be configured via software interfaces.)

Note: Be sure the voltage applied on the contacts is within the specification of 30VDC/1A max. or 120VAC/0.5A max.

3. Managing the Switch

The switch provides the following methods to configure and monitor the switch as follows:

- Making out of band management via RS-232 console port
- Making in-band management via telnet interface over TCP/IP network
- Making in-band management via web interface over TCP/IP network
- Making in-band SNMP management over TCP/IP network

3.1 IP Address & Password

The IP Address is an identification of the switch in a TCP/IP network. Each switch should be designated a new and unique IP address in the network. The switch is shipped with the following factory default settings for software management:

Default IP address of the switch: `192.168.0.2 / 255.255.255.0`

Fixed Username: `admin`

Privilege level: `15`

No password

The switch supports local authentication instead of RADIUS authentication with factory defaults. No password is required with factory default. However, the password is used for local authentication in accessing to the switch via console, telnet and Http web-based interface. For security reason, it is recommended to change the default settings for the switch before deploying it to your network.

3.2 Configuring IP Address via console and telnet CLI

The steps to configure a fixed IPv4 address for the switch via CLI are:

Example for Fixed IP address:

```
# configure terminal
(config)# interface vlan 1
(config-if-vlan)# ip address 192.168.4.171 255.255.255.0
```

Remark:

1. With factory default, vlan 1 is the only one that includes all switched ports as port members.
2. Address `192.168.4.171 255.255.255.0` is assigned to vlan 1.

Example for DHCP:

```
# configure terminal
(config)# interface vlan 1
(config-if-vlan)# ip address dhcp fallback 192.168.4.171 255.255.255.0
```

Remark:

1. With factory default, vlan 1 is the only one that includes all switched ports as port members.
2. vlan 1 uses dhcp for IP configuration.
3. Address `192.168.4.171 255.255.255.0` is the fallback IP address when dhcp server is not available.

3.3 Configuring Local Authentication via console and telnet CLI

Example:

```
(config)# username michael privilege 15 password unencrypted 12345
```

Remark:

1. The username example is Michael and the password is unencrypted 12345.
2. Michael is given privilege 15, the highest level.
3. The username and password is used as local authentication for CLI and web UI.

Since default username `admin` can not be deleted and not protected with password, it is necessary to configure a password for `admin` for security purpose.

Configure password for default username `admin`:

```
(config)# username admin password unencrypted 12345
```

Password `unencrypted 12345` is an example.

3.4 Configuring IP Address & Password via Web Interface

Start Web Browser

Start your browser software and enter the default IP address to which you want to connect. The IP address is used as URL for the browser software to search the device.

URL: http://192.168.0.2/

Login to the switch

When browser software connects to the switch successfully, a Login screen is provided for you to login to the device as the left display below:



Enter the following default values in the login page:

Fixed User Name: **admin**

No password is required.

Click **OK** to login into the switch.

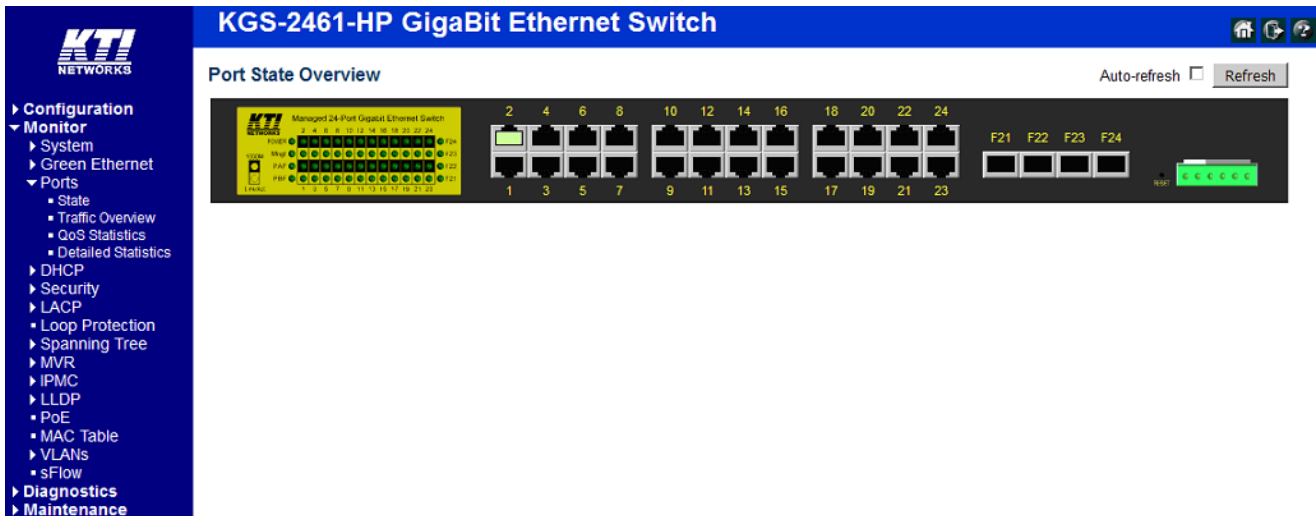

IP Address Configuration

Select [Configuration] -> [System] -> [IP] to configure IP address for VLAN 1

KGS-2461-HP GigaBit Ethernet Switch

IP Configuration

Mode: Host
 DNS Server: No DNS server
 DNS Proxy:

IP Interfaces

Delete	VLAN	IPv4 DHCP			IPv4		IPv6	
		Enable	Fallback	Current Lease	Address	Mask Length	Address	Mask Length
<input type="checkbox"/>	1	<input checked="" type="checkbox"/>	0		192.168.0.187	24		

Add Interface

IP Routes

Delete	Network	Mask Length	Gateway	Next Hop VLAN
--------	---------	-------------	---------	---------------

Add Route

Save Reset

Configuration

Description

IPv4 DHCP

DHCP client configuration

Enable

Enable the DHCP client by checking this box. If this option is enabled, the system will configure the IPv4 address and mask of the interface using the DHCP protocol.

Fallback

The number of seconds for trying to obtain a DHCP lease. After this period expires, a configured IPv4 address will be used as IPv4 interface address. A value of zero disables the fallback mechanism, such that DHCP will keep retrying until a valid lease is obtained. Legal values are 0 to 4294967295 seconds.

Current Lease

For DHCP interfaces with an active lease, this column shows the current interface address, as provided by the DHCP server.

Address

The IPv4 address of the interface in dotted decimal notation. If DHCP is enabled, this field configures the fallback address. The field may be left blank if IPv4 operation on the interface is not desired - or no DHCP fallback address is desired.

Mask Length

The IPv4 network mask, in number of bits (*prefix length*). Valid values are between 0 and 30 bits for a IPv4 address. If DHCP is enabled, this field configures the fallback address network mask. The field may be left blank if IPv4 operation on the interface is not desired - or no DHCP fallback address is desired.

Save

Click to save the changes.

Reset

Click to undo any changes made locally and revert to previously saved values.

User Configuration

Select [Configuration] -> [Security] -> [Switch] -> [Users] to configure a new user, Michael as an example.

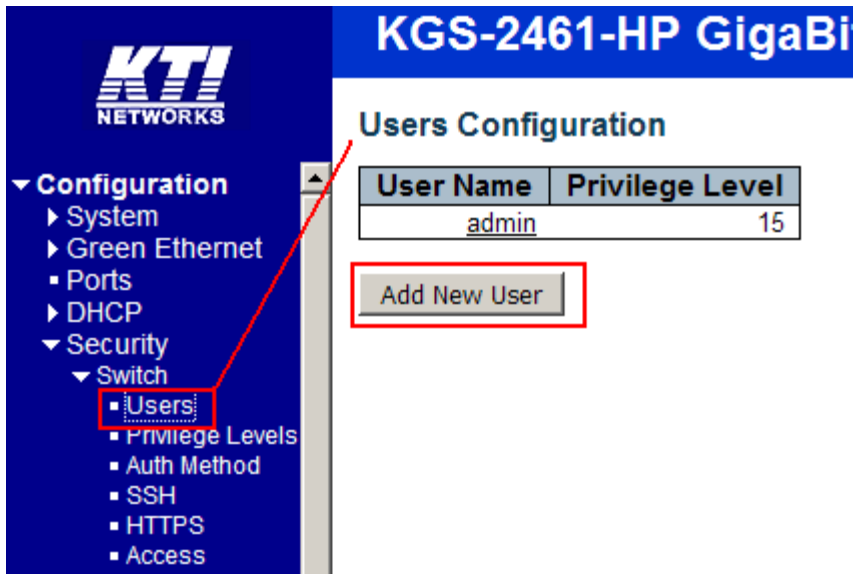

Configuration

Description

User Name

The name identifying the user. This is also a link to Add/Edit User interface.

Privilege Level

The privilege level of the user. The allowed range is 1 to 15. If the privilege level value is 15, it can access all groups, i.e. that is granted the fully control of the device. But others value need to refer to each group privilege level. User's privilege should be same or greater than the group privilege level to have the access of that group. By default setting, most groups privilege level 5 has the read-only access and privilege level 10 has the read-write access. And the system maintenance (software upload, factory defaults and etc.) need user privilege level 15. Generally, the privilege level 15 can be used for an administrator account, privilege level 10 for a standard user account and privilege level 5 for a guest account.

Add New User

Click to add a new user.

Add New User

Add User

User Settings	
User Name	michael
Password	●●●●●
Password (again)	●●●●●
Privilege Level	15

Configuration	Description
User Name	A string identifying the user name that this entry should belong to. The allowed string length is 1 to 31. The valid user name allows letters, numbers and underscores.
Password	The password of the user. The allowed string length is 0 to 31. Any printable characters including space are accepted.
Password (again)	Re-enter the password again.
Privilege Level	The privilege level of the user. The allowed range is 1 to 15. If the privilege level value is 15, it can access all groups, i.e. that is granted the fully control of the device. But others value need to refer to each group privilege level. User's privilege should be same or greater than the group privilege level to have the access of that group. By default setting, most groups privilege level 5 has the read-only access and privilege level 10 has the read-write access. And the system maintenance (software upload, factory defaults and etc.) need user privilege level 15. Generally, the privilege level 15 can be used for an administrator account, privilege level 10 for a standard user account and privilege level 5 for a guest account.

<input type="button" value="Save"/>	Click to save the changes.
<input type="button" value="Reset"/>	Click to undo any changes made locally and revert to previously saved values.
<input type="button" value="Cancel"/>	Click to undo any changes made locally and return to the Users.

Click

Users Configuration

User Name	Privilege Level
admin	15
michael	15

Configure password for admin user

Select [Configuration] -> [Security] -> [Switch] -> [Users] to show all users.

Users Configuration

User Name	Privilege Level
admin	15
michael	15

Add New User

Click admin to edit configuration.

Users Configuration

User Name	Privilege Level
admin	15
michael	15

Add New User

Click

Edit user page to configure password for admin user:

Edit User

User Settings	
User Name	admin
Password	
Password (again)	
Privilege Level	15

Save Reset Cancel

3.5 Reference Manuals for Web, Console, Telnet Management

The following operation manuals are also provided separately for Console, Telnet and Web management:

Operation manual - telnet & console management xxxxxx.doc

Operation manual - web management xxxxx.doc

The manuals describe the detailed commands and information.

3.6 Configuration for SNMP Management

The switch supports SNMP v1, SNMP v2c, and SNMP v3 management. Make sure the related settings are well-configured for the switch before you start the SNMP management from an SNMP manager.

Using Telnet CLI

The following are available commands in telnet SNMP command group to configure SNMP-related settings:

```
(config)# snmp-server ?
    access          access configuration
    community       Set the SNMP community
    contact         Set the SNMP server's contact string
    engine-id       Set SNMP engine ID
    host            Set SNMP host's configurations
    security-to-group security-to-group configuration
    trap           Set trap's configurations
    user           Set the SNMPv3 user's configurations
    version        Set the SNMP server's version
    view           MIB view configuration
```

Using Web Interface

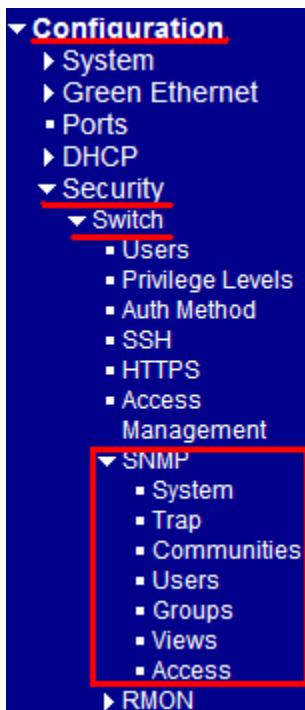

The commands supports configuration for:

- Basic system configuration for SNMP v1, SNMP v2c and SNMP v3
- Basic system configuration for SNMP v1 trap, SNMP v2c trap and SNMP v3 trap
- Communities that permit to access to SNMPv3 agent
- User table for SNMPv3
- Group table for SNMPv3
- Viewer table for SNMPv3
- Accesses group table for SNMPv3

3.7 SNMP MIBs

The switch provides the following SNMP MIBs:

RFC 1213 - MIB II	MIB for Network Management of TCP/IP-based internets.
RFC 2674 - Q-Bridge MIB (VLAN MIB)	VLAN Bridge MIB module for managing Virtual Bridged LANs, as defined by IEEE802.1Q-1998.
RFC 2819 - RMON (Group 1, 2, 3 & 9)	MIB module for managing remote monitoring device implementations.
RFC 2863 - Interface Group (IF) MIB	MIB module to describe generic objects for network interface sub-layers.
RFC 3411 - SNMP Management Frameworks	
RFC 3414 - User Based Security Model (USM)	MIB module for the SNMP User-based Security Model.
RFC 3415 - View Based Access Control Model (VACM)	MIB module for the View-based Access Control Model for SNMP,
RFC 3635 - EtherLike MIB	MIB module to describe generic objects for Ethernet-like network interfaces.
RFC 3636 - 802.3 Medium Attachment Units (MAUs) MIB	MIB module for 802.3 MAU.
RFC 4133 - Entity MIB	MIB module for representing multiple logical entities supported by a single SNMP agent.
RFC 4188 - Bridge MIB	Bridge MIB module for managing devices that support IEEE 802.1D
RFC4292-IP-Forwarding-MIB	
RFC4293-IP-MIB	
RFC4668 - RADIUS Authentication Client MIB	MIB module for entities implementing the client side of the RADIUS authentication protocol.
RFC4670-RADIUS-ACC-CLIENT-MIB	MIB module for entities implementing the client side of the

	RADIUS accounting protocol.
RFC 5519 - Multicast Group Membership Discovery (MGMD) MIB	MIB module for MGMD management (Obsoletes RFC 2933 and RFC 3019 MIBs)
IEEE 802.1 MSTP MIB	MIB module for managing devices that support IEEE 802.1 multiple spanning tree groups.
IEEE 802.1AB LLDP MIB	MIBs defined in 802.1AB.
IEEE 802.1X Port Access Entity (PAE) MIB	MIBs defined in 802.1X.
IEEE 802.1-Q-BRIDGE MIB	The VLAN Bridge MIB module for managing Virtual Bridged LANs, as defined by IEEE 802.1Q-2005.
IEEE 802.3ad Link Aggregation (LAG) MIB	MIBs defined in 802.3ad.
TIA 1057 LLDP Media Endpoint Discovery (MED) MIB	The LLDP MIB extension module for TIA-TR41.4 Media Endpoint Discovery information.
Private - SFLOW MIB	

One product MIB file is also available in the product CD for SNMP manager software.