



# 10/100BASE-TX TO 100BASE-FX MEDIA CONVERTERS

KC-300D Series

Installation Guide



(C) 2003 KTI Networks Inc. All rights reserved. No part of this documentation may be reproduced in any form or by any means or used to make any directive work (such as translation or transformation) without permission from KTI Networks Inc.

KTI Networks Inc. reserves the right to revise this documentation and to make changes in content from time to time without obligation on the part of KTI Networks Inc. to provide notification of such revision or change.

For more information, contact:

**United States**

KTI Networks Inc.  
P.O. BOX 631008  
Houston, Texas 77263-1008

Phone: 713-2663891  
Fax: 713-2663893  
E-mail: [kti@ktinet.com](mailto:kti@ktinet.com)  
URL: <http://www.ktinet.com/>

**International**

Fax: 886-2-26983873  
E-mail: [kti@ktinet.com.tw](mailto:kti@ktinet.com.tw)  
URL: <http://www.ktinet.com.tw/>

The information contained in this document is subject to change without prior notice. Copyright (C) All Rights Reserved.

## TRADEMARKS

Ethernet is a registered trademark of Xerox Corp.

## FCC NOTICE

This device complies with Class B Part 15 the FCC Rules. Operation is subject to the following two conditions: (1) This device may not cause harmful interference, and (2) this device must accept any interference received including the interference that may cause.

## CE NOTICE

Marking by the symbol  indicates compliance of this equipment to the EMC directive of the European Community. Such marking is indicative that this equipment meets or exceeds the following technical standards:

### EMI

EN55022:2006 + A1:2007	CISPR22:2006 Class B
EN61000-3-2:2006	IEC61000-3-2:2005
EN61000-3-3:1995+A1:2001+A2:2005	IEC61000-3-3:1994+A1:2001+A2:2005

### EMS

EN55024:1998 + A1:2001 + A2:2003	CISPR24:1997
EN61000-4-2:2001	IEC61000-4-2:2001
EN61000-4-3:2002 + A1:2002	IEC61000-4-3:2002 + A1:2002
EN61000-4-4:2004	IEC61000-4-4:2004
EN61000-4-5:2001	IEC61000-4-5:2001
EN61000-4-6:2003	IEC61000-4-6:2003
EN61000-4-8:2001	IEC61000-4-8:2001
EN61000-4-11:2001	IEC61000-4-11:2001

# Table of Contents

<b>1. Introduction .....</b>	<b>5</b>
1.1 Key Features .....	5
1.2 Specifications .....	6
1.3 Optical Specifications .....	10
1.4 Special Functions .....	11
<b>2. Installation .....</b>	<b>13</b>
2.1 Unpacking .....	13
2.2 Mounting the Device .....	13
2.3 Applying Power .....	14
2.4 Making TP Port Connection .....	15
2.5 Making FX Port Connection .....	16
2.6 LED Indicators .....	18
<b>3. Optional Configuration Settings .....</b>	<b>19</b>
3.1 User Inaccessible Jumpers .....	19
3.1.1 Forwarding Mode Setting JP1 .....	20
3.1.2 802.3x Function Setting JP2 .....	21
3.1.3 FX Duplex Setting JP3 .....	21
3.2 JP1-JP3 Factory Default Settings .....	21

# 1. Introduction

---

The 10/100BASE-TX to 100BASE-FX media converter series provides a media conversion allowing high-speed integration of fiber optic and twisted-pair segments. With 10BASE-T and 100BASE-TX support, the converters provide seamless translation between Ethernet and Fast Ethernet networks. A complete set of LEDs allows for quick status verification.

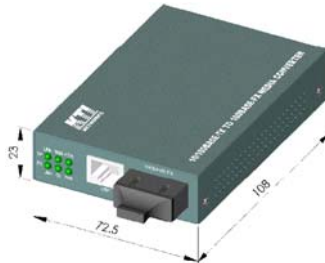

## 1.1 Key Features

The media converters also provide the following key features:

- Convert speed and media type
- Support full wire speed conversion
- Support 10Mbps and 100Mbps speed on TP connections
- Auto MDI/MDI-X detection function on the TP port
- Auto-negotiation function on the TP port
- Link fault pass through function
- Provide manual configuration settings for TP port to support connection to non-auto-negotiation devices
- Transparent to 802.1Q VLAN tagged packets
- Far End Fault function on FX port
- Support wide range of fiber options on the FX port
- Support media converter center chassis installation
- Support center chassis management
- Provide user-inaccessible settings for specific system applications
- Low power consumption

## 1.2 Specifications

LED Indicators

Twisted-pair Interface (TP Port)

Front Panel

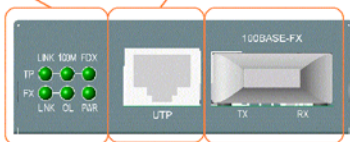

Fiber Optic Interface (FX Port)

DC Power Input

Connector for center installation

Rear Panel

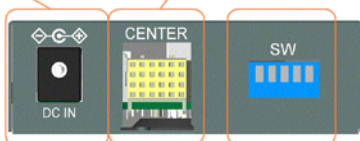

User Accessible Settings (SW)

### **Twisted-Pair Interface (TP Port)**

Connector	Shielded RJ-45
Pin Assignments	Auto MDI/MDI-X detection
Signal Compliance	IEEE 802.3 10BASE-T, 802.3u 100BASE-TX
Data Speed	10Mbps or 100Mbps
Duplex Mode	Half-duplex or Full-duplex
Configuration	Auto-negotiation capable and optional forced manual settings
Cable Types	10Mbps - Category 3, 4, or 5 UTP 100Mbps - Category 5 UTP
Supported Link Distance	Up to 100 meters

### **Fiber Optic Interface (FX Port)**

Signal Compliance	IEEE 802.3u 100BASE-FX
Connector	SC, ST, MT-RJ, VF-45, LC or Single SC
Data Speed	100Mbps
Duplex Mode	Full-duplex and optional half duplex
Cable Types	Multimode (MMF) - 50/125, 62.5/125 $\mu$ m Single mode (SMF) - 9/125 $\mu$ m
Supported Link Distance	MMF up to 2km SMF up to 100km Single SMF WDM up to 40km
Eye Safety compliance	IEC825 Class 1

### **User Accessible Settings (SW)**

<b>NO.</b>	<b>SETTING</b>	<b>STATE</b>	<b>FUNCTION</b>
SW1	TP Port Configuration	OFF ON	Auto-negotiation (default) Forced mode
SW2	TP Port Duplex	OFF ON	Full duplex (default) Half duplex
SW3	TP Port Speed	OFF ON	100Mbps (default) 10Mbps
SW4	Link Fault Pass Through	OFF ON	Disable (default) Enable
SW5	Reserved		

### **Optional Settings (User inaccessible JP1-JP3 on board)**

<b>NO.</b>	<b>SETTING</b>	<b>STATE</b>	<b>FUNCTION</b>
JP1	Forwarding mode	Open Short	Store-and-forward (default) Smart-forward mode
JP2	802.3x function	Open Short	Enable (default) Disable
JP3	FX port duplex	Open Short	Full duplex mode (default) Half duplex mode

## LED Indicators

<b>LED</b>	<b>DISPLAY</b>	<b>STATE</b>	<b>INTERPRETATION</b>
PWR	Power status	ON	Power on
		OFF	Power off
TP LINK	TP port link status	ON	Link up and no traffic
		OFF	Link fault
		Blink	Rx/Tx activities
TP 100M	TP port speed status	ON	100Mbps
		OFF	10Mbps
TP FDX	TP port duplex status	ON	Full duplex
		OFF	Half duplex
		Blink	Collisions on half duplex
FX LINK	FX port link status	ON	Link up and no traffic
		OFF	Link fault
		Blink	Rx/Tx activities
FX OL	FX port optical link	ON	Optical signal is detected
		OFF	No optical signal

## DC Power Input

DC Input Jack	D 6.3mm —  + D 2.0mm
Operating Input Voltages	+4.75V ~ +12.6V
Power consumption	2W max. (0.27A @ +7.5V)
Power Supply Options	External AC-DC power adapters Rated AC 100-240V/50-60Hz DC 7.5V 0.5A min. Rated AC 120V/60Hz DC 7.5V 0.5A min. Rated AC 230V/50Hz DC 7.5V 0.5A min. Rated AC 240V/50Hz DC 7.5V 0.5A min. Rated AC 100V/50-60Hz DC 7.5V 0.5A min. Rated AC 100V/50-60Hz DC 5V 1A

## Center Connector

Connector	Futurebus 6x4
Function	Center chassis installation
Signals	Power inputs Ground Management interfaces



### **Basic Information**

Forwarding Throughput	Full wire speed at 100M full duplex 10Mbps - 14,880 pps at 64-byte packets 100Mbps - 148,800pps at 64-byte packets
Packet Types	Transparent and no modification for - IEEE 802.3 standard packets - IEEE 802.1Q VLAN tagged packets
Packet Length	Up to 1522 bytes at store-and-forward mode No limit at smart-forward mode 100to100
Flow Control	Back-pressure for half-duplex mode 802.3x pause-frame base for full duplex mode

### **Mechanical**

Dimension	H 23mm x W 72.5mm x D 108mm
Housing	Enclosed metal with no fan
Mounting	Desktop, Wall mount, Center chassis
Weight	210g

### **Environmental**

Operating Temperature	-20°C ~ 60°C (KC-300D-EC) -5°C ~ 50°C (Other models)
Storage Temperature	-20°C ~ 85°C
Relative Humidity	5% ~ 90%

### **Certificate**

FCC	Part 15 Class B
CE/EMC	EMI EN50081-1 Class B, EMS EN55024
CE/LVD	EN 60950

## 1.3 Optical Specifications

The media converter series provides the following fiber options:

### Duplex Fiber Series

<u>Model</u>	<u>Port</u>	<u>Fiber</u>	<u>Wavelength</u>	<u>Tx Power</u>	<u>Rx Sensitivity</u>
300D-T	ST	MMF	1310nm	-19 ~ -14dBm	-31dBm
300D-C	SC	MMF	1310nm	-19 ~ -14dBm	-31dBm
300D-EC	SC	MMF	1310nm	-20 ~ -14dBm	-31dBm
300D-JM	MT-RJ	MMF	1310nm	-19 ~ -14dBm	-31dBm
300D-VM	VF-45	MMF	1310nm	-20 ~ -14dBm	-31dBm
300D-SA2	SC	SMF	1310nm	-15 ~ -8dBm	-31dBm
300D-SL2	SC	SMF	1310nm	-15 ~ -8dBm	-32dBm
300D-SL3	SC	SMF	1310nm	-15 ~ -8dBm	-34dBm
300D-SL4	SC	SMF	1310nm	-5 ~ 0dBm	-34dBm
300D-SL6	SC	SMF	1310nm	-5 ~ 0dBm	-35dBm
300D-SL7	SC	SMF	1310nm	-3 ~ +3dBm	-37dBm
300D-SL9	SC	SMF	1310nm	0 ~ +5dBm	-37dBm
300D-SL10	SC	SMF	1550nm	-3 ~ +3dBm	-37dBm
300D-SL12	SC	SMF	1550nm	0 ~ +5dBm	-37dBm

### Single Fiber Bi-Di WDM Series

<u>Model</u>	<u>Port</u>	<u>Fiber</u>	<u>Wavelength</u>	<u>Tx Power</u>	<u>Rx Sensitivity</u>
300D-W3515	SC	SMF	Tx 1310nm Rx 1550nm	-14 ~ -8dBm	-31dBm
300D-W5315	SC	SMF	Tx 1550nm Rx 1310nm	-14 ~ -8dBm	-31dBm
300D-W3540	SC	SMF	Tx 1310nm Rx 1550nm	-8 ~ 0dBm	-34dBm
300D-W5340	SC	SMF	Tx 1550nm Rx 1310nm	-8 ~ 0dBm	-34dBm

### Single Mode CWDM Series

<u>Model</u>	<u>Port</u>	<u>Fiber</u>	<u>Wavelength</u>	<u>Tx Power</u>	<u>Rx Sensitivity</u>
300D-CxxW40	SC	SMF	Tx 1xx0nm Rx 1100-1650nm	-5 ~ 0dBm	-35dBm
300D-CxxW50	SC	SMF	Tx 1xx0nm Rx 12600-1620nm	-4 ~ +3dBm	-35dBm
300D-CxxW80	SC	SMF	Tx 1xx0nm Rx 1100-1650nm	0 ~ +5dBm	-37dBm

## 1.4 Special Functions

### Auto MDI/MDI-X Function

This function allows the TP port to auto-detect the twisted-pair signals and adapts itself to form a valid MDI to MDI-X connection with the remote connected device automatically.

### Auto-negotiation Function

When TP port is set on Auto-negotiation mode (SW1:ON), it is featured with auto-negotiation function and full capability. It performs a negotiation process for the speed and duplex configuration with the connected device automatically when each time a link is being established.

### Far End Fault Function

The FX port is facilitated with this function, which conforms to IEEE 802.3u 100BASE-FX specifications. When the FX port detects a link failure on its receiving circuitry, it will send out an FEFI (Far End Fault Indication) signal to the remote connected device to indicate a remote fault is detected. It also is capable to receive FEFI signal sent from the remote link partner. Upon receiving an FEFI signal, it indicates a link failure occurred on the transmitting path. This function allows the converter to report a fiber link fault even when a link failure occurred on transmitting fiber cable.

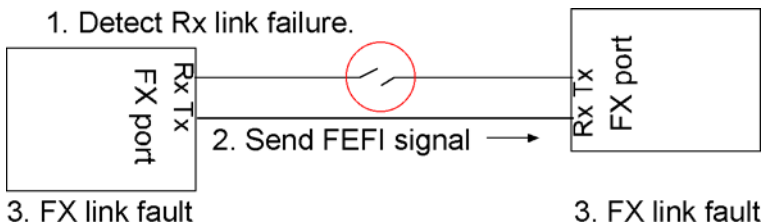

### Link Fault Pass Through Function

When this function is enabled, a link fault detected on the TP port will force a link down on the FX port. Similarly, a link fault detected on the FX port will also force a link down on the TP port. As illustrated in the following figure, this function allows to pass TP link fault to the remote link partner and makes the converter like a TP cable extender.

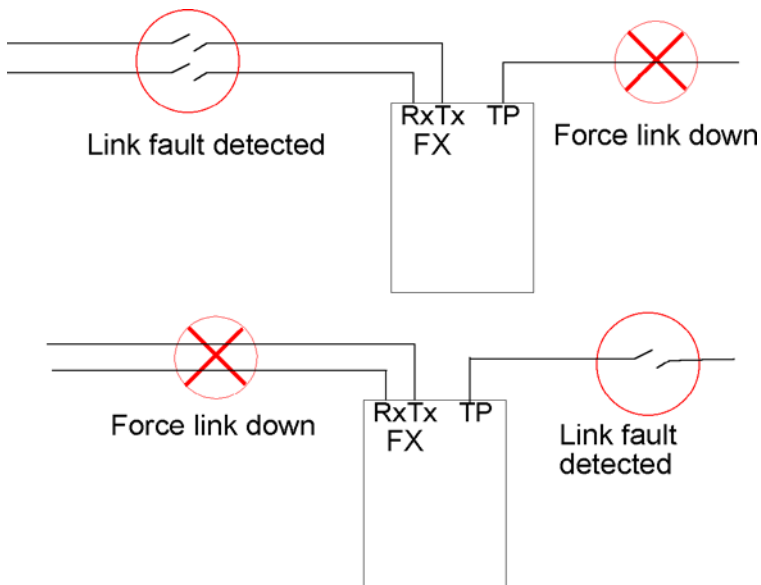

## **2. Installation**

---

### **2.1 Unpacking**

Check that the following components have been included:

- Installation guide (or contained in the product CD)
- 10/100 Media Converter
- One AC power adapter

If any item is found missing or damaged, please contact your local reseller for replacement.

### **2.2 Mounting the Device**

#### **Desktop Mounting**

The media converter can be mounted on a desktop or shelf. Make sure that there is proper heat dissipation from and adequate ventilation around the device. Do not place heavy objects on the device.

#### **Wall Mounting**

The media converter also can be mounted on a wall. On bottom of the device, wall mounting hole is provided for wall mounting.

#### **Installation into Center Chassis KC-1300**

The media converter also can be installed in KC-1300 center chassis. The center chassis provides the power supply to the converter. Up to 16 units can be installed in one chassis. Unscrew and remove the cover of the center connector before inserting the converter into the chassis. Refer to the operation manual of center chassis KC-1300 for more information.

## 2.3 Applying Power

Before you begin the installation, check the AC voltage of your area. The AC power adapter which is used to supply the DC power for the unit should have the AC voltage matching the commercial power voltage in your area.

### The AC Power Adapter Specifications

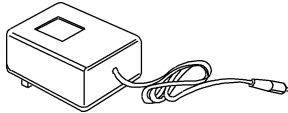

AC input power:      AC power voltage of your area, options -  
Rated AC 100-240V/50-60Hz DC 7.5V 0.5A min.  
Rated AC 120V/60Hz DC 7.5V 0.5A min.  
Rated AC 230V/50Hz DC 7.5V 0.5A min.  
Rated AC 240V/50Hz DC 7.5V 0.5A min.  
Rated AC 100V/50-60Hz DC 7.5V 0.5A min.  
Rated AC 100V/50-60Hz DC 5V 1A

Steps to apply the power to the converters are:

1. Connect power adapter DC plug to the DC input jack located on the back of the converter before connecting to the AC outlet.
2. To ensure against accidental disconnection, tie the DC cable with the cable tie located the back of the converter.
3. Connect the power adapter to the AC outlet.
4. Check Power LED indication.

## 2.4 Making TP Port Connection

TP port is featured to support connection to :

- Auto-negotiation devices
- Auto-negotiation incapable 10BASE-T devices
- Auto-negotiation incapable 100BASE-TX devices

### Network Cables

10BASE-T: 2-pair UTP Cat. 3,4,5 , EIA/TIA- 568 100-ohm STP

100BASE-TX: 2-pair UTP Cat. 5, EIA/TIA-568 100-ohm STP

Link distance: Up to 100 meters

### Configuration Setup

To make a proper connection, the following configuration settings are recommended:



#### TP port link partner

Auto-negotiation device

Fixed 10M half duplex device

Fixed 100M half duplex device

Fixed 10M full duplex device

Fixed 100M full duplex device

#### SW1

Off: auto

On: forced

On: forced

On: forced

On: forced

#### SW2

Off: full duplex

On: half duplex

On: half duplex

Off: full duplex

Off: full duplex

#### SW3

Off: 100M

On: 10M

Off: 100M

On: 10M

Off: 100M

## 2.5 Making FX Port Connection

FX port operates on 100Mbps and full duplex (factory default). A variety of fiber options is provided as follows:

### Duplex Fiber Series

<u>Model</u>	<u>Connector</u>	<u>Wavelength</u>	<u>Fiber</u>	<u>Ref. distance</u>
300D-T	ST	1310nm	Duplex MMF	2km
300D-C	SC	1310nm	Duplex MMF	2km
300D-JM	MT-RJ	1310nm	Duplex MMF	2km
300D-VM	VF-45	1310nm	Duplex MMF	2km
300D-SA2	SC	1310nm	Duplex SMF	20km
300D-SL2	SC	1310nm	Duplex SMF	20km
300D-SL3	SC	1310nm	Duplex SMF	30km
300D-SL4	SC	1310nm	Duplex SMF	40km
300D-SL6	SC	1310nm	Duplex SMF	60km
300D-SL7	SC	1310nm	Duplex SMF	70km
300D-SL9	SC	1310nm	Duplex SMF	90km
300D-SL10	SC	1550nm	Duplex SMF	100km
300D-SL12	SC	1550nm	Duplex SMF	120km

### Duplex Fiber CWDM Series

<u>Model</u>	<u>Connector</u>	<u>Wavelength</u>	<u>Fiber</u>	<u>Ref. Distance</u>
300D-CxxW40	SC	Tx 1xx0nm Rx 1100 - 1650nm	SMF	40km
300D-CxxW50	SC	Tx 1xx0nm Rx 1260 - 1620nm	SMF	50km
300D-CxxW80	SC	TX 1xx0nm RX 1100 - 1650nm	SMF	80km

Tx 1xx0nm : 1470, 1490, 1510, 1530, 1550, 1570, 1590, 1610nm



## Single Fiber Bi-Di WDM Series

<u>Model</u>	<u>Connector</u>	<u>Wavelength</u>	<u>Fiber</u>	<u>Ref. Distance</u>
300D-W3515	Bi-Di SC	Tx 1310nm Rx 1550nm	Single SMF	15 - 20km
300D-W5315	Bi-Di SC	Tx 1550nm Rx 1310nm	Single SMF	15 - 20km
300D-W3540	Bi-Di SC	Tx 1310nm Rx 1550nm	Single SMF	40km
300D-W5340	Bi-Di SC	Tx 1550nm Rx 1310nm	Single SMF	40km

Since the WDM single fiber media converters use different wavelengths for transmission and receiving respectively, the link partner device located on the remote end of the single fiber should match the wavelength used on the single fiber converter.

## 2.6 LED Indicators

### Link Fault Pass Through Function is disabled

<u>LED</u>	<u>Display</u>	<u>Status</u>	<u>Interpretation</u>
PWR	Power status	On	Power on
		Off	Power off
TP LINK	TP port link status	On	Link up and no traffic
		Off	Link fault
		Blink	Rx/Tx activities
TP 100M	TP port speed status	On	100Mbps
		Off	10Mbps
TP FDX	TP port duplex status	On	Full duplex
		Off	Half duplex
		Blink	Collisions on half duplex
FX LINK	FX port link status	On	Link up and no traffic
		Off	Link fault
		Blink	Rx/Tx activities
FX OL	FX port optical link	On	Optical signal is detected
		Off	No optical signal is detected

### Link Fault Pass Through Function is enabled

<u>TP LINK</u>	<u>FX LINK</u>	<u>FX OL</u>	<u>Interpretation</u>
On	On	On	Both TP and FX ports link up
Off	Off	On	(1) TP port link fault or (2) FX port received FEFI signal (FX port Tx path failed.)
Off	Off	Off	(1) TP port link fault or (2) FX port Rx link failure detected

## 3. Optional Configuration Settings

---

The media converter provides additional configuration settings which are user-inaccessible. The settings are built on the board inside the product case. The settings are provided for technical installers to adapt the converter to fit some specific application needs.

### 3.1 User Inaccessible Jumpers

The setting jumpers are not accessible by users generally. For accessing these jumpers, the upper case must be removed from the product. Removing the case must be performed by an authorized and experienced technical person. The setting jumper block is located on the position shown below:

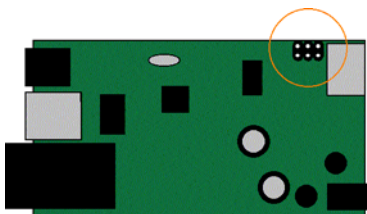

The setting functions are as follows:

JP1	Forwarding mode setting	Open - Store-and-forward mode Short - Smart-forward mode
JP2	802.3x function setting	Open - Enable Short - Disable
JP3	FX port duplex setting	Open - Full duplex mode Short - Half duplex mode

### 3.1.1 Forwarding Mode Setting JP1

The following table lists the forward method used in different TP to FX conversions:

<b><u>JP1 Setting</u></b>	<b><u>TP port to/from FX port</u></b>	<b><u>Forward method</u></b>
Store-and-forward	10BASE-T to 100BASE-FX	Store and forward
	100BASE-TX to 100BASE-FX	Store and forward
Smart-forward	10BASE-T to 100BASE-FX	Store and forward
	100BASE-TX to 100BASE-FX	Direct conversion

On smart-forward mode, the converter can change to direct conversion automatically when it detects same speed on both TP port and FX port. Direct conversion method converts the signal between TP port and FX port without storing the received packet on one port then forwarding to another port. The media converter operates with the minimum latency.

Note:

1. In direct conversion, be sure both devices connected to the TP port and FX port have same duplex mode for proper transmission.
2. In direct conversion, 802.3x function is disabled and the media converter will not generate pause frame, but just forwards the received pause frame directly from one port to another port.
3. In direct conversion, the media converter is not limited to the maximal length of the receiving packets.

### **3.1.2 802.3x Function Setting JP2**

IEEE 802.3x function is the flow control method used for full duplex operation on TP port and FX port under store and forward mode. This method uses pause frames for one port to stop further transmission from its link partner.

### **3.1.3 FX Duplex Setting JP3**

This setting is used to set the duplex mode of the FX port.

## **3.2 JP1-JP3 Factory Default Settings**

The factory default settings for JP1, JP2, and JP3 are as follows:

JP1	Open	Store-and-forward mode
JP2	Open	802.3x function is enabled
JP3	Open	FX port full duplex